

# Grove GMK4115L

## Product Guide

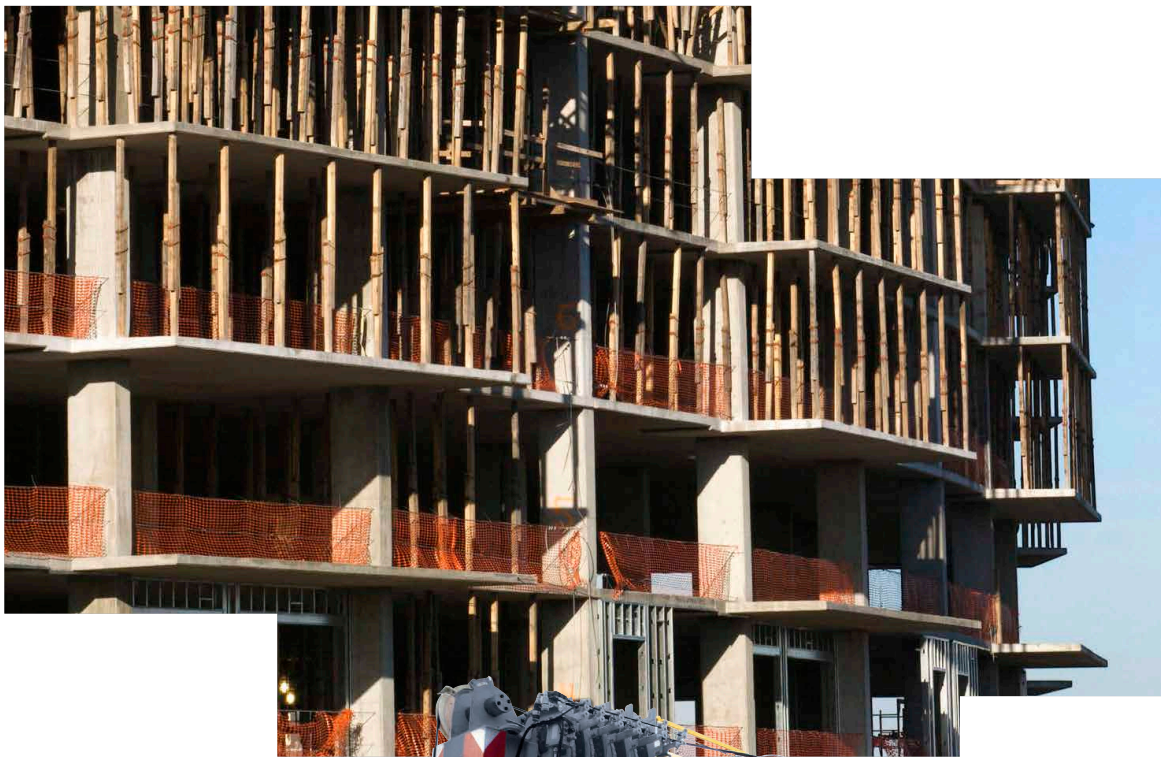

### Features

- 100 t (115 USt) capacity
- 11,7 m – 60 m (38 ft – 197 ft) seven-section full power MEGAFORM™ boom with TWINLOCK™ pinning
- 10 m – 17 m (33 ft – 56 ft) hydraulic offset bi-fold swingaway
- 26,1 t (57,500 lb) counterweight with hydraulic removal system
- MEGATRAK™ independent hydro-pneumatic suspension



# Features

## MEGATRAK™

The MEGATRAK™ suspension system is the best off road driveline available on the market today. The system's versatility and performance allows the GMK4115L to operate as a true all-terrain crane. The MEGATRAK™ independent suspension and all-wheel steer system allows wheels to remain on the ground at all times so stresses and weight are not continually transferred between axles. MEGATRAK™ provides true ground clearance where others just raise the chassis.

Other benefits of the MEGATRAK™ system are:

- A reliable suspension system
- Excellent job site maneuverability with all-wheel steering
- Commonality among almost all models
- A driveline that remains aligned at all times
- A steering linkage system that is protected against damage
- Constant tire contact for equal tire wear
- Reduced maintenance



## TWIN-LOCK™

Boom pinning mechanism automatically pins the sections in position using two horizontal pins.

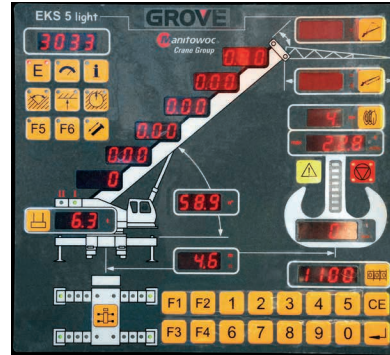

## EKS 5 Light

Monitoring the lifting condition of the crane at all times EKS works together with, but independently of the ECOS as a complete command and control system or separately as a load moment indicator.

## CraneSTAR

CraneSTAR is an exclusive and innovative crane asset management system that helps improve your profitability and reduce costs by remotely monitoring critical crane data. Visit [www.cranestar.com](http://www.cranestar.com) for more information.



## ECOS

Electronic Crane Operating System - ECOS enables control of the entire crane's principle operations. Simple programming eases lift planning and a supply of essential information allows full concentration on the lift itself.

# Contents

Specifications	4
Dimensions	7
Weight proposals	8
Counterweight dimensions	9
Working range (main boom)	10
Load charts (main boom)	11
Working range (swingaway and extensions)	14
Load charts (swingaway and extensions)	15
Working range (integrated heavy duty jib)	18
Load charts (integrated heavy duty jib)	19

# Specifications

## Superstructure



### Boom

11,7 m – 60 m (38 ft – 197 ft) 7 section, full power MEGAFORM™ boom with TWIN-LOCK™ pinning. Maximum tip height: 63 m (207 ft).



### Boom nose

Seven nylatron sheaves, mounted on heavy duty tapered roller bearings with removable pin-type rope guards. Quick reeve boom nose. Removable auxiliary boom nose with removable pin type rope guard.



### Boom elevation

Single lift cylinder with safety valve provides boom angle from  $-1.5^{\circ}$  to  $+82^{\circ}$ .



### Hydraulic offsettable lattice extension

10 m – 17 m (33 ft – 56 ft) bi-fold lattice swingaway extension, hydraulically offsettable and luffing under load,  $0^{\circ}$ –  $40^{\circ}$ .

Maximum tip height: 80 m (262 ft).



### \*Offsettable lattice extension

10 m – 17 m (33 ft – 56 ft) bifold lattice swingaway extension, manually offsettable at  $0^{\circ}$ ,  $20^{\circ}$  and  $40^{\circ}$ .

Maximum tip height: 80 m (262 ft).



### \*Lattice extension

(1) 5 m (16 ft) insert for use with lattice swingaway extension to increase length to 22 m (72 ft).

Maximum tip height: 85 m (279 ft).



### Load moment and anti-two block system

Load moment and anti-two block system with audio/visual warning and control lever lockout provides electronic display of boom angle, length, radius, tip height, relative load moment, maximum permissible load, load indication and warning of impending two-block condition.



## Cab

All aluminum constructed cab with acoustical lining, hydraulic tilted to  $20^{\circ}$ . Includes tinted safety glass, adjustable operator's seat, opening windows at side and rear, hinged windshield with wiper, sun visor and window shade. Other features include hot water heater/defroster, armrest integrated crane controls, drive/steer controls and ergonomically arranged instrumentation.

## Crane control system

Full electronic control of all crane movements using electrical control levers with automatic reset to zero. Controls are integrated with the LMI and engine management system by CAN-BUS. ECOS system with semi-graphic display.



## Swing

2 axial piston planetary gear boxes with fixed displacement motors. Infinitely variable to 1.9 rpm. Free swing with holding (rocker switch) and service (foot pedal) brake.



## Counterweight

26,1 t (57,500 lb) consisting of various sections with hydraulic installation/removal system controlled from the superstructure cab.



## Engine

Mercedes-Benz OM 904 LA direct injected, after cooled with 110 kW (148 bhp) at 2200 rpm.

Max torque: 580 Nm (428 ft-lb)  $\tau$  1200 rpm.

Engine emission: EUROMOT/EPA/CARB Tier III (non road)



## Fuel tank

230 L (61 gal) Integrated in carrier fuel tank.



## Hydraulic system

2 separate circuits, 1 axial piston variable displacement pump (load sensing) with electronic power limiting control and 1 gear pump for swing.

Thermostatically controlled oil coolers keep oil at optimum operating temperature.

Tank capacity: 600 L (158 gal)



# Specifications

## Superstructure continued



### Hoist

Main and auxiliary hoist are powered by axial piston motor with planetary gear and multiple disc brake. "Thumb-thumper" hoist drum rotation indicator alerts operator of hoist movement.

	Main	Auxiliary
Line length:	255 m (837 ft)	255 m (837 ft)
Rope diameter:	17 mm	17 mm
Line speed:	120 m/min (394 fpm)	120 m/min (394 fpm)
Line pull:	56 kN (12,589 lb)	56 kN (12,589 lb)

### \*Optional hookblocks

Lifting capacity	Sheaves	Weight	Parts of line	Possible load with the crane*
100 t (110 USt)	7	1000 kg (2200 lb)	2-15	82 t (90 USt)
63 t (70 USt)	5	750 kg (1653 lb)	2-11	61 t (67 USt)
40 t (44 USt)	3	550 kg (1213 lb)	1-7	39 t (43 USt)
20 t (22 USt)	1	300 kg (661 lb)	1-3	17 t (18.7 USt)
8 t (8.8 USt)	H/B	200 kg (440 lb)	1	5,7 t (6.3 USt)

\* varies depending on national regulations



### Electrical system

24V system with three phase alternator, 28V/80A.  
2 batteries 12V/170 Ah.

### \*Optional equipment

- ▣ Base boom mounted work lights
- ▣ Boom mounted aircraft warning light
- ▣ Stainless steel exhaust system with spark arrestor
- ▣ Diesel heater, also serves as engine preheater includes 24 hour timer for preheater
- ▣ Engine independent propane gas cab heater
- ▣ Additional worklight for superstructure cab
- ▣ Stereo radio/CD player
- ▣ Air conditioning
- ▣ Drive and steer control for superstructure

- ▣ EKS 5 with full graphic display
- ▣ 3,3 m (10.8 ft) side-stowed 3-sheave heavy duty jib
- ▣ Additional fuel tank for superstructure 185 L (49 gal) integrated in swingaway

## Carrier



### Chassis

Box type, torsion resistant frame is fabricated from high strength steel.



### Outrigger system

Four hydraulic single stage outrigger beams with vertical cylinders and outrigger pads, 500 mm (19.7 in) square. Outrigger can be set in 5 positions:

Full	7 m (23 ft)
Partial	6 m (19.6 ft)
Partial	5 m (16.4 ft)
Partial	4 m (13.2 ft)
Retracted	2,6 m (8.4 ft)

Independent horizontal and vertical movement controlled from each side of carrier and the superstructure cab. Electronic crane level indicators. Includes outrigger monitoring system.



### Engine

Mercedes-Benz OM 460 LA direct injected with 315 kW (422 bhp) at 1800 rpm.

Max torque: 2000 Nm (1549 ft-lb) at 1300 rpm.

Engine emission: EUROMOT/EPA/CARB Tier IVi (non-road)



### Fuel tank capacity

400 L (106 gal). Supplies superstructure and carrier engines.



### Transmission

Daimler Chrysler, G240-16

16 forward and 2 reverse speeds

2 speed transfer case



### Drive/steer

8x6x8

# Specifications

## Carrier continued

### Axles

1st axle line – drive/steer  
2nd axle line – steer/(optional drive)  
3rd axle line – drive/steer (connects for all-wheel steer)  
4th axle line – drive/steer  
Drive axles with planetary hub reduction and center mounted gearing. Standard inter-axle and cross axle differential locks.

### Suspension

Grove's exclusive MEGATRAK™ suspension. Independent hydro-pneumatic system acting on all wheels with hydraulic lockout. Suspension can be raised 170 mm (6.7 in) or lowered 130 mm (5.1 in) both longitudinally and transversely. Features an automatic leveling system for highway travel.

### Tires

8 tires, 445/95 R25 (16.00 R25)  
(Vehicle width – 2,75 m [9.0 ft]).

### Steering

Dual circuit, hydraulic power assisted steering system. Transfer case mounted, ground driven emergency steering pump. Axles 1, 2, and 4 steer on highway. Separate steering of the 3rd and 4th axles for all wheel and crab steering, controlled by an electronic rocker switch.

### Brakes

Service brakes: pneumatic dual circuit acting on all wheels.  
Parking brake: pneumatically operated spring loaded brake acting on axle lines 2 and 4.  
Standard anti-lock prevention (ABS).  
Air dryer.

### Cab

wo-man design with the following features: safety glass, driver seat with suspension, power windows, heated rear view mirrors, complete instrumentation and driving controls. Air conditioning and engine independent diesel air heater included with 24 hour timer.

ECOS control of suspension, drive connect and disconnect, inter-axle locks, differential locks and all-wheel steer.

### Electrical system

24V system with three phase alternator, 28V/100A  
2 batteries, 12V/170 Ah

### Maximum speed

85 km/h (53 mph)

### Gradeability (theoretical)

63.7% - 14.00 tires  
56.7% - 16.00/20.5 tires

### Miscellaneous standard equipment

Work lights for outrigger; tool kit; fire extinguisher; auxiliary boom nose; radio /CD player in carrier cab, wind speed indicator and CraneSTAR asset management system.

### \*Optional equipment

- ▶ Stainless steel exhaust system with spark arrestor
- ▶ 385/95 R25 (14.00 R25) tires (vehicle width 2,75 m [9.0 ft])
- ▶ 525/80 R25 (20.5 R25) tires (vehicle width 2,88 m [9.8 ft])
- ▶ Spare tire and wheel with carry bracket
- ▶ 8x8x8 drive/steer (additional drive, axle #2)
- ▶ Electric driveline retarder
- ▶ Steel outrigger pads
- ▶ Outrigger pad load indicator
- ▶ Trailer and towing hitches
- ▶ Engine independent diesel cab heater, with engine pre-heater
- ▶ Additional strobe lights
- ▶ Working range limiter
- ▶ Wireless remote control for all crane functions
- ▶ Data logger
- ▶ Rear mounted stowage box
- ▶ Engine upgrade to 335 kW (449 bhp)  
360° NYC house lock
- ▶ Optional engine: Tier III Mercedes-Benz OM 460 LA, 295 kW (395 ho) at 1800 rpm. Max. torque 1900 Nm at 1300 rpm.

# Dimensions

## Dimensions

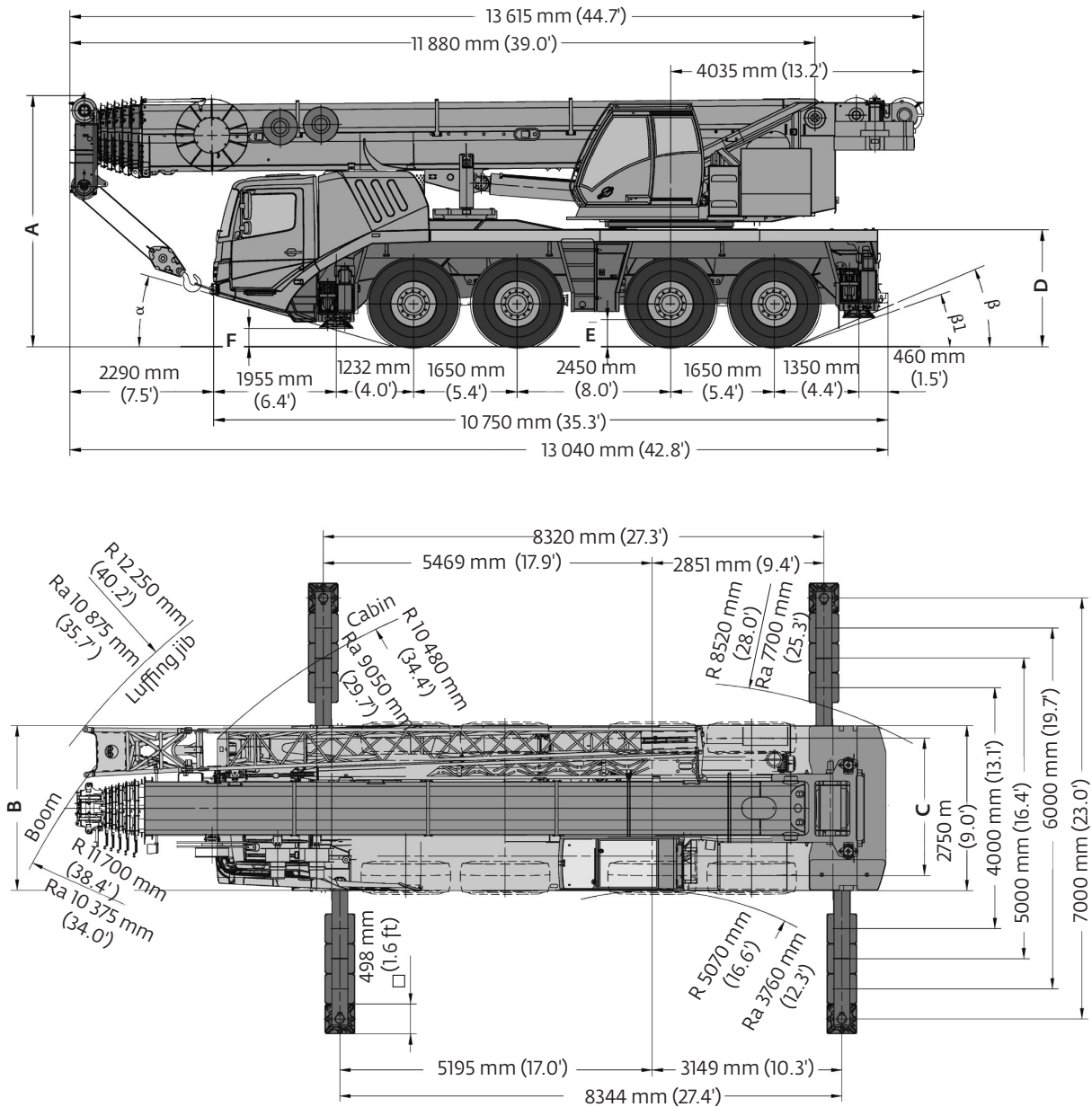

	A	A <sup>100 mm (0.4')</sup>	B	C	D	E	F	$\alpha$	$\beta$	$\beta_1$
14.00 R25	3940 mm (12.9')	3810 mm (12.5')	2750 mm (9.0')	2320 mm (7.6')	1750 mm (5.7')	435 mm (1.4')	262 mm (0.9')	14°	21°	17°
16.00 R25	3990 mm (13.1')	3860 mm (12.7')	2750 mm (9.0')	2280 mm (7.5')	1863 mm (6.1')	485 mm (1.6')	292 mm (1.0')	16°	23°	19°
20.5 R25	3990 mm (13.1')	3860 mm (12.7')	2880 mm (9.4')	2320 mm (7.6')	1863 mm (6.1')	485 mm (1.6')	292 mm (1.0')	16°	23°	19°

Ra = Radius all wheels steered  
<sup>1</sup>Lowered

# Weight proposals

## Trailing boom weights

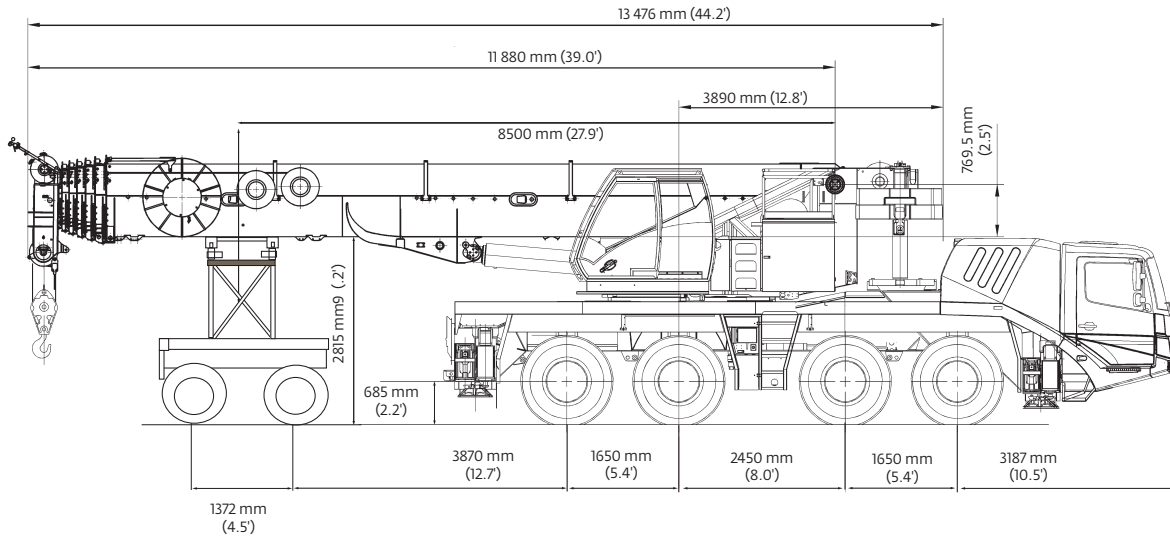

Basic Weights - kg (lb)	Axles 1 and 2		Axles 3 and 4		2 Dolly axles		Total	
Mercedes-Benz power Tier IVi, 16.00 tires, 8x6x8 drive/steer, outrigger pads stowed, auxiliary hoist, 56 ft hydraulic luffing swingaway stowed, additional oil cooler, 3500 kg (7716 lb) counterweight slab bolted to superstructure and 2590 kg (5710 lb) boom dolly, 16 USt of extend boom boost with boom telescoped 9.8 ft.	17 993	(39,666)	18 044	(39,779)	14 984	(33,034)	51 020	(112,478)
<b>Additions:</b>								
14.00R25 tires	-240	(-529)	-240	(-529)	—	—	-480	(1058)
20.5R25 tires	168	(370)	168	(370)	—	—	336	(741)
8x8x8 drive/steer	261	(575)	69	(152)	—	—	330	(728)
<b>Removals:</b>								
Hydraulic hose reel	15	(33)	5	(11)	-189	(-417)	-170	(-375)
Brackets for swingaway	-17	(-37)	-5	(-11)	-63	(-139)	-85	(-187)
10 m – 17 m (33 ft – 56 ft) swingaway	-177	(-390)	-55	(-121)	-1098	(-2421)	-1330	(-2932)
Front and rear outrigger floats	-59	(-130)	-61	(-134)	—	—	-120	(-265)

## Boom over front

Basic Weights - kg (lb)	Axles 1 and 2		Axles 3 and 4		Total	
Mercedes-Benz power Tier IVi, 16.00R25 tires, 8x6x8 drive/steer, 2nd oil cooler, outrigger pads, auxiliary hoist, auxiliary boom nose driver and tanks filled, 3500 kg (7700 lb) counterweight bolted to superstructure.	24 687	(54,426)	22 026	(48,559)	46 713	(102,985)
<b>Additions:</b>						
8x8x8 drive/steer	261	(575)	69	(152)	330	(728)
Electric driveline retarder	-27	(-59)	287	(633)	260	(573)
Spare wheel 14.00 R25 XGC steel rim with stowage	-179	(-395)	439	(968)	260	(573)
Spare wheel 16.00 R25 XGC steel rim with stowage	-222	(-490)	542	(1195)	320	(705)
Spare wheel 20.5 R25 XGC steel rim with stowage	-254	(-560)	616	(1358)	362	(798)
Brackets for hydraulic swingaway	100	(222)	-14	(-32)	86	(190)
Hose reel + parts for hydraulic swingaway	345	(761)	-175	(-387)	170	(375)
10 m – 17 m (33 ft – 56 ft) hydraulic swingaway	1798	(3964)	-468	(-1032)	1330	(2932)
4850 lb (2200 kg) section 3 pinned to superstructure	-1304	(-2875)	3504	(7725)	2200	(4850)
4850 lb (2200 kg) section 8 stowed on carrier	2189	(4826)	11	(24)	2200	(4850)
<b>Substitutions:</b>						
14.00R25 tires	-240	(-529)	-240	(-529)	-480	(-1058)
20.5R25 tires	168	(370)	168	(370)	336	(741)
<b>Removals:</b>						
Auxiliary boom nose	143	(315)	-83	(-183)	-60	(-132)
Front and rear outrigger floats	-59	(-129)	-61	(-136)	-120	(-265)



# Counterweight dimensions

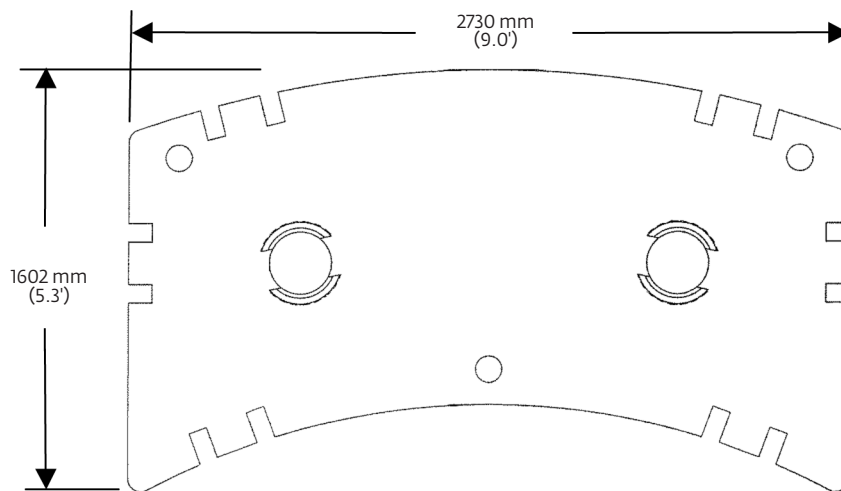
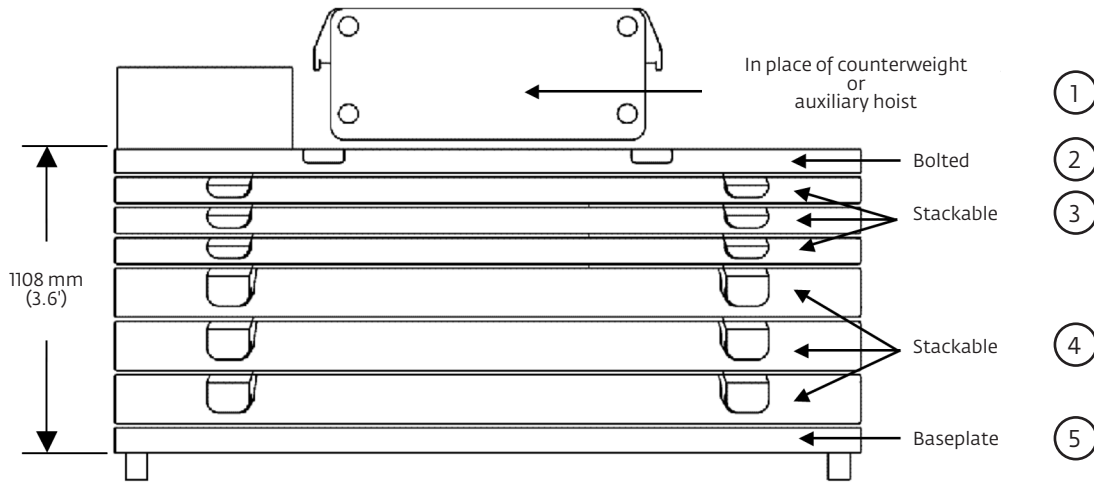

	① 600 (1300)	② 3500 (7700)	③ 2200 (4850)	④ 4400 (9700)	⑤ 2200 (4850)
Counterweight configuration kg (lb)					
4100 (9000)	X	X			
6300 (13,800)	X	X			X
8500 (18,700)	X	X	X		X
10 700 (23,500)	X	X		X	X
12 900 (28,400)	X	X	X	X	X
15 100 (33,200)	X	X		2X	X
17 300 (38,100)	X	X	X	2X	X
19 500 (42,900)	X	X	2X	2X	X
21 700 (47,800)	X	X	X	3X	X
23 900 (52,600)	X	X	2X	3X	X
26 100 (57,500)	X	X	3X	3X	X

# Working range

## Main boom

38 ft – 197 ft main boom

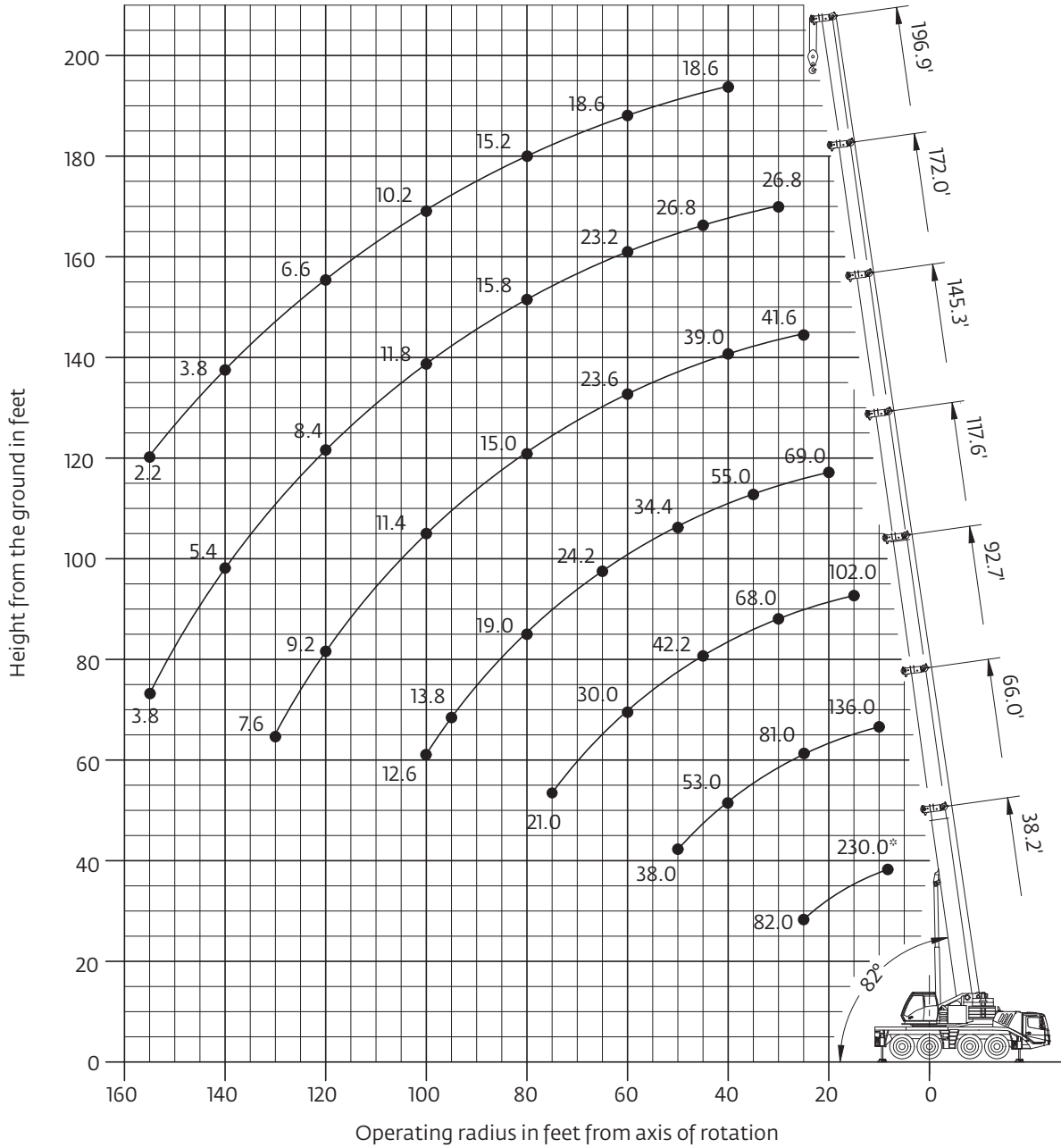

Hook heights shown in the working range diagram do not consider loaded boom deflection.

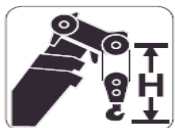



	Hook block	H
	70 Ust, 5 sheave	3000 mm (9.8 ft)
	40 Ust, 3 sheave	2900 mm (9.5 ft)
	20 Ust, 1 sheave	2800 mm (9.2 ft)
	8 Ust, single line headache ball	2350 mm (7.7 ft)

THIS CHART IS ONLY A GUIDE AND SHOULD NOT BE USED TO OPERATE THE CRANE.



The individual crane's load chart, operating instructions and other instructional plates must be read and understood prior to operating the crane.

# Load charts

## Main boom









11,7 m – 60 m  
(38.2 ft – 196.9 ft)
     
 26 100 kg  
(57,500 lb)
     
 27.3 ft x 23.0 ft  
100%
     
 360°





**Pounds x 1000**

Feet	38.2	52.2	66.0	79.6	92.7	105.4	117.6	131.5	145.3	158.9	172.0	184.7	196.9
8.0	*230.0	–	–	–	–	–	–	–	–	–	–	–	–
10.0	160.0	146.0	136.0	130.0	–	–	–	–	–	–	–	–	–
15.0	124.0	121.0	114.0	108.0	102.0	–	–	–	–	–	–	–	–
20.0	99.0	100.0	95.0	93.0	87.0	84.0	69.0	53.0	–	–	–	–	–
25.0	82.0	84.0	81.0	79.0	77.0	74.0	69.0	53.0	41.6	–	–	–	–
30.0	–	71.0	71.0	69.0	68.0	65.0	64.0	52.0	41.6	33.2	26.8	–	–
35.0	–	61.0	62.0	60.0	59.0	55.0	55.0	48.0	41.2	33.2	26.8	22.0	–
40.0	–	52.0	53.0	50.0	49.0	48.0	46.0	43.4	39.0	33.0	26.8	22.0	18.6
45.0	–	–	43.8	43.2	42.2	42.6	39.8	37.2	35.8	32.6	26.8	22.0	18.6
50.0	–	–	38.0	38.4	36.4	37.0	34.4	32.2	31.0	30.4	26.6	22.0	18.6
55.0	–	–	–	33.0	32.8	32.6	30.2	30.2	27.0	26.6	25.6	22.0	18.6
60.0	–	–	–	28.8	30.0	28.8	26.6	27.2	23.6	23.4	23.2	21.8	18.6
65.0	–	–	–	25.2	26.6	25.6	24.2	24.2	20.8	20.6	20.6	20.8	18.6
70.0	–	–	–	–	23.6	22.8	23.0	21.6	18.4	18.4	18.2	18.6	18.2
75.0	–	–	–	–	21.0	20.2	21.4	19.4	16.4	17.2	16.8	17.2	17.0
80.0	–	–	–	–	–	18.6	19.0	17.6	15.0	16.2	15.8	16.2	15.2
85.0	–	–	–	–	–	17.8	17.0	15.8	13.8	15.4	14.6	15.0	13.8
90.0	–	–	–	–	–	16.2	15.4	14.2	12.8	14.6	13.4	13.6	12.4
95.0	–	–	–	–	–	–	13.8	12.6	12.0	13.4	12.6	12.4	11.2
100.0	–	–	–	–	–	–	12.6	11.2	11.4	12.2	11.8	11.2	10.2
105.0	–	–	–	–	–	–	–	10.0	10.8	11.0	11.0	10.2	9.2
110.0	–	–	–	–	–	–	–	9.2	10.2	10.0	10.0	9.4	8.2
115.0	–	–	–	–	–	–	–	8.0	9.8	9.2	9.2	8.4	7.4
120.0	–	–	–	–	–	–	–	–	9.2	8.8	8.4	7.6	6.6
125.0	–	–	–	–	–	–	–	–	8.4	8.2	7.4	6.8	5.8
130.0	–	–	–	–	–	–	–	–	7.6	7.4	6.8	6.0	5.2
135.0	–	–	–	–	–	–	–	–	–	6.6	6.0	5.4	4.4
140.0	–	–	–	–	–	–	–	–	–	6.0	5.4	4.6	3.8
145.0	–	–	–	–	–	–	–	–	–	–	4.8	4.2	3.2
150.0	–	–	–	–	–	–	–	–	–	–	4.2	3.6	2.6
155.0	–	–	–	–	–	–	–	–	–	–	3.8	3.0	2.2
160.0	–	–	–	–	–	–	–	–	–	–	–	2.6	–
165.0	–	–	–	–	–	–	–	–	–	–	–	2.2	–

\*over rear with special equipment

11,7 m – 60 m  
(38.2 ft – 196.9 ft)
     
 22 900 kg  
(52,600 lb)
     
 27.3 ft x 23.0 ft  
100%
     
 360°



**Pounds x 1000**

Feet	38.2	52.2	66.0	79.6	92.7	105.4	117.6	131.5	145.3	158.9	172.0	184.7	196.9
10.0	160.0	146.0	136.0	130.0	–	–	–	–	–	–	–	–	–
15.0	124.0	121.0	114.0	108.0	102.0	–	–	–	–	–	–	–	–
20.0	99.0	100.0	95.0	93.0	87.0	84.0	69.0	53.0	–	–	–	–	–
25.0	82.0	83.0	81.0	79.0	77.0	74.0	69.0	53.0	41.6	–	–	–	–
30.0	–	71.0	71.0	69.0	68.0	64.0	63.0	52.0	41.6	33.2	26.8	–	–
35.0	–	61.0	60.0	56.0	56.0	53.0	52.0	48.0	41.2	33.2	26.8	22.0	–
40.0	–	50.0	50.0	48.0	47.0	47.0	43.8	41.0	39.0	33.0	26.8	22.0	18.6
45.0	–	–	41.6	42.2	39.8	40.2	37.4	35.0	33.6	32.6	26.8	22.0	18.6
50.0	–	–	36.2	36.4	35.8	35.0	32.4	32.2	29.0	28.6	26.6	22.0	18.6
55.0	–	–	–	31.0	32.4	30.6	28.2	28.8	25.2	24.8	24.6	22.0	18.6
60.0	–	–	–	26.8	28.4	27.0	25.8	25.6	22.0	21.8	21.6	21.8	18.6
65.0	–	–	–	25.2	25.0	24.0	24.2	22.6	19.4	19.4	19.0	19.4	18.6
70.0	–	–	–	–	22.0	21.2	22.2	20.2	17.2	18.4	17.8	18.2	17.6
75.0	–	–	–	–	19.4	19.8	19.8	18.2	16.0	17.2	16.8	17.0	15.8
80.0	–	–	–	–	–	18.6	17.8	16.4	15.0	16.2	15.8	15.4	14.2
85.0	–	–	–	–	–	16.6	15.8	14.6	13.8	15.0	14.6	13.8	12.6
90.0	–	–	–	–	–	15.0	14.2	13.0	12.8	13.6	13.4	12.6	11.4
95.0	–	–	–	–	–	–	12.8	11.4	12.0	12.4	12.0	11.4	10.2
100.0	–	–	–	–	–	–	11.4	10.2	11.4	11.2	11.0	10.4	9.2
105.0	–	–	–	–	–	–	–	9.8	10.8	10.2	10.2	9.4	8.2
110.0	–	–	–	–	–	–	–	9.2	10.0	9.8	9.2	8.4	7.4
115.0	–	–	–	–	–	–	–	7.0	9.2	8.8	8.2	7.6	6.6
120.0	–	–	–	–	–	–	–	–	8.2	8.0	7.4	6.8	5.8
125.0	–	–	–	–	–	–	–	–	7.4	7.2	6.6	6.0	5.0
130.0	–	–	–	–	–	–	–	–	7.0	6.6	6.0	5.2	4.4
135.0	–	–	–	–	–	–	–	–	–	5.8	5.2	4.6	3.6
140.0	–	–	–	–	–	–	–	–	–	5.4	4.6	4.0	3.0
145.0	–	–	–	–	–	–	–	–	–	–	4.0	3.4	2.6
150.0	–	–	–	–	–	–	–	–	–	–	3.6	2.8	2.0
155.0	–	–	–	–	–	–	–	–	–	–	3.0	2.4	–
160.0	–	–	–	–	–	–	–	–	–	–	–	2.0	–

THIS CHART IS ONLY A GUIDE AND SHOULD NOT BE USED TO OPERATE THE CRANE.

# Load charts

## Main boom

 11,7 m – 60 m  
 (38.2 ft – 196.9 ft)

 19 500 kg  
 (42,900 lb)

 27.3 ft x 23.0 ft  
 100%

 360°

		Pounds x 1000											
Feet	38.2	52.2	66.0	79.6	92.7	105.4	117.6	131.5	145.3	158.9	172.0	184.7	196.9
10.0	159.0	146.0	136.0	130.0	–	–	–	–	–	–	–	–	–
15.0	123.0	120.0	114.0	108.0	102.0	–	–	–	–	–	–	–	–
20.0	98.0	100.0	95.0	93.0	87.0	84.0	69.0	53.0	–	–	–	–	–
25.0	82.0	83.0	81.0	79.0	77.0	73.0	69.0	53.0	41.6	–	–	–	–
30.0	–	70.0	67.0	62.0	61.0	59.0	57.0	52.0	41.6	33.2	26.8	–	–
35.0	–	56.0	54.0	53.0	50.0	50.0	47.0	43.4	41.2	33.2	26.8	22.0	–
40.0	–	44.0	46.0	44.0	43.4	42.0	39.0	36.8	34.8	33.0	26.8	22.0	18.6
45.0	–	–	38.0	37.6	38.0	35.8	33.2	33.6	29.6	29.0	26.8	22.0	18.6
50.0	–	–	31.6	32.6	32.8	31.0	30.2	29.0	25.4	24.8	24.6	22.0	18.6
55.0	–	–	–	29.0	28.6	27.0	27.6	25.4	21.8	22.2	21.6	21.6	18.6
60.0	–	–	–	25.0	24.8	23.8	24.4	22.4	19.6	20.8	20.2	20.2	18.6
65.0	–	–	–	21.8	21.6	22.0	21.6	19.8	18.2	19.4	19.0	18.4	17.0
70.0	–	–	–	–	18.8	20.2	19.2	17.4	17.2	17.6	17.6	16.4	15.0
75.0	–	–	–	–	17.6	17.8	17.0	15.6	16.0	15.8	15.6	14.6	13.2
80.0	–	–	–	–	–	15.8	15.0	13.8	15.0	14.8	14.0	13.0	11.8
85.0	–	–	–	–	–	14.2	13.4	12.2	13.8	13.6	12.6	11.6	10.4
90.0	–	–	–	–	–	12.6	11.8	11.4	12.6	12.4	11.4	10.4	9.2
95.0	–	–	–	–	–	–	10.6	10.8	11.4	11.2	10.2	9.2	8.2
100.0	–	–	–	–	–	–	9.4	10.2	10.2	10.0	9.2	8.2	7.2
105.0	–	–	–	–	–	–	–	9.8	9.2	9.0	8.4	7.4	6.2
110.0	–	–	–	–	–	–	–	9.0	8.4	8.0	7.4	6.6	5.4
115.0	–	–	–	–	–	–	–	5.4	7.6	7.2	6.4	5.8	4.8
120.0	–	–	–	–	–	–	–	–	6.8	6.4	5.8	5.0	4.0
125.0	–	–	–	–	–	–	–	–	6.0	5.6	5.0	4.2	3.4
130.0	–	–	–	–	–	–	–	–	5.4	5.0	4.4	3.6	2.8
135.0	–	–	–	–	–	–	–	–	–	4.4	3.8	3.0	2.2
140.0	–	–	–	–	–	–	–	–	–	3.8	3.2	2.6	–
145.0	–	–	–	–	–	–	–	–	–	–	2.6	2.0	–
150.0	–	–	–	–	–	–	–	–	–	–	2.2	–	–

 11,7 m – 60 m  
 (38.2 ft – 196.9 ft)

 12 900 kg  
 (28,400 lb)

 27.3 ft x 23.0 ft  
 100%

 360°

		Pounds x 1000											
Feet	38.2	52.2	66.0	79.6	92.7	105.4	117.6	131.5	145.3	158.9	172.0	184.7	196.9
10.0	158.0	146.0	136.0	130.0	–	–	–	–	–	–	–	–	–
15.0	122.0	120.0	114.0	108.0	102.0	–	–	–	–	–	–	–	–
20.0	98.0	99.0	95.0	91.0	87.0	80.0	69.0	53.0	–	–	–	–	–
25.0	78.0	76.0	72.0	69.0	65.0	64.0	59.0	53.0	41.6	–	–	–	–
30.0	–	59.0	57.0	54.0	54.0	51.0	47.0	43.2	41.2	33.2	26.8	–	–
35.0	–	45.0	46.0	44.0	44.0	41.2	38.0	38.2	33.6	32.6	26.8	22.0	–
40.0	–	35.2	36.8	38.4	36.6	34.4	34.6	31.8	27.6	27.2	26.4	22.0	18.6
45.0	–	–	31.4	32.2	31.0	30.0	29.4	26.8	24.6	25.4	24.0	22.0	18.6
50.0	–	–	26.0	26.8	26.4	27.0	25.2	23.0	22.8	22.6	22.4	20.8	18.6
55.0	–	–	–	22.6	22.8	23.4	21.8	19.8	21.2	20.6	19.4	18.0	16.6
60.0	–	–	–	19.4	20.8	20.6	19.0	18.2	18.8	18.0	17.0	15.6	14.2
65.0	–	–	–	17.2	18.0	17.8	16.6	16.8	17.0	16.0	14.8	13.6	12.4
70.0	–	–	–	–	15.8	15.4	14.6	15.4	15.0	14.0	13.2	12.0	10.6
75.0	–	–	–	–	13.8	13.8	12.8	14.2	13.4	12.4	11.6	10.4	9.2
80.0	–	–	–	–	–	12.6	11.6	12.6	12.0	11.2	10.2	9.2	8.0
85.0	–	–	–	–	–	11.4	11.0	11.2	10.6	9.8	9.0	8.0	6.8
90.0	–	–	–	–	–	10.2	10.0	10.0	9.4	8.8	8.0	7.0	5.8
95.0	–	–	–	–	–	–	9.0	8.8	8.2	7.8	7.0	6.0	4.8
100.0	–	–	–	–	–	–	6.2	7.8	7.2	6.8	6.2	5.2	4.0
105.0	–	–	–	–	–	–	–	6.8	6.4	6.0	5.4	4.4	3.4
110.0	–	–	–	–	–	–	–	6.0	5.6	5.2	4.6	3.8	2.6
115.0	–	–	–	–	–	–	–	2.6	4.8	4.4	3.8	3.0	2.0
120.0	–	–	–	–	–	–	–	–	4.2	3.8	3.2	2.4	–
125.0	–	–	–	–	–	–	–	–	3.6	3.2	2.6	–	–
130.0	–	–	–	–	–	–	–	–	3.0	2.6	2.0	–	–
135.0	–	–	–	–	–	–	–	–	–	2.2	–	–	–

THIS CHART IS ONLY A GUIDE AND SHOULD NOT BE USED TO OPERATE THE CRANE.

The individual crane's load chart, operating instructions and other instructional plates must be read and understood prior to operating the crane.

# Load charts

## Main boom





11,7 m – 60 m  
 (38.2 ft – 196.9 ft)

8500 kg  
 (18,700 lb)

27.3 ft x 23.0 ft  
 100%

360°

		Pounds x 1000											
Feet	38.2	52.2	66.0	79.6	92.7	105.4	117.6	131.5	145.3	158.9	172.0	184.7	196.9
10.0	157.0	146.0	136.0	130.0	–	–	–	–	–	–	–	–	–
15.0	121.0	120.0	114.0	108.0	102.0	–	–	–	–	–	–	–	–
20.0	97.0	93.0	87.0	81.0	76.0	74.0	68.0	53.0	–	–	–	–	–
25.0	66.0	68.0	65.0	61.0	60.0	56.0	51.0	47.0	41.6	–	–	–	–
30.0	–	50.0	50.0	49.0	47.0	43.8	41.8	40.0	34.6	33.2	26.8	–	–
35.0	–	38.2	39.6	40.0	37.8	35.6	35.2	32.2	29.4	28.2	26.4	22.0	–
40.0	–	29.0	32.2	32.6	31.0	31.4	29.2	26.4	26.6	25.8	24.2	21.6	18.6
45.0	–	–	26.0	26.8	26.6	26.4	24.4	23.4	23.8	22.8	21.4	19.8	18.2
50.0	–	–	21.4	22.2	23.8	22.6	20.8	21.6	20.8	19.6	18.4	16.8	15.4
55.0	–	–	–	19.8	20.0	19.4	18.0	19.0	18.0	16.8	15.8	14.4	13.0
60.0	–	–	–	16.8	17.2	17.4	16.6	16.6	15.6	14.6	13.6	12.4	11.0
65.0	–	–	–	14.4	14.8	15.4	15.2	14.6	13.6	12.8	11.8	10.6	9.2
70.0	–	–	–	–	12.6	13.4	13.4	13.0	12.0	11.2	10.2	9.0	7.8
75.0	–	–	–	–	11.2	11.6	11.6	11.4	10.6	9.8	8.8	7.8	6.6
80.0	–	–	–	–	–	10.2	10.2	10.0	9.2	8.6	7.6	6.6	5.4
85.0	–	–	–	–	–	8.8	8.8	8.6	8.2	7.4	6.6	5.6	4.4
90.0	–	–	–	–	–	7.8	7.6	7.6	7.0	6.4	5.6	4.6	3.6
95.0	–	–	–	–	–	–	6.6	6.6	6.0	5.6	4.8	3.8	2.8
100.0	–	–	–	–	–	–	4.2	5.6	5.2	4.8	4.0	3.2	2.0
105.0	–	–	–	–	–	–	–	5.0	4.4	4.0	3.4	2.4	–
110.0	–	–	–	–	–	–	–	4.2	3.8	3.2	2.6	–	–
115.0	–	–	–	–	–	–	–	–	3.0	2.6	2.0	–	–
120.0	–	–	–	–	–	–	–	–	2.6	2.0	–	–	–
125.0	–	–	–	–	–	–	–	–	2.0	–	–	–	–





11,7 m – 60 m  
 (38.2 ft – 196.9 ft)

4100 kg  
 (9000 lb)

27.3 ft x 23.0 ft  
 100%

360°

		Pounds x 1000											
Feet	38.2	52.2	66.0	79.6	92.7	105.4	117.6	131.5	145.3	158.9	172.0	184.7	196.9
10.0	156.0	146.0	136.0	130.0	–	–	–	–	–	–	–	–	–
15.0	121.0	121.0	114.0	105.0	98.0	–	–	–	–	–	–	–	–
20.0	85.0	81.0	77.0	71.0	69.0	63.0	57.0	52.0	–	–	–	–	–
25.0	54.0	57.0	55.0	55.0	51.0	47.0	46.0	42.0	36.0	–	–	–	–
30.0	–	41.2	43.0	41.4	38.8	38.8	35.8	32.4	31.2	28.2	25.8	–	–
35.0	–	30.6	33.2	32.6	32.8	31.2	28.6	28.4	28.0	25.8	24.0	20.8	–
40.0	–	22.6	25.8	26.4	27.0	25.4	24.0	24.6	23.0	21.6	20.2	18.6	16.8
45.0	–	–	20.8	22.6	22.6	22.2	21.6	20.6	19.4	18.2	16.8	15.4	13.8
50.0	–	–	16.8	18.6	19.0	19.0	18.4	17.6	16.4	15.4	14.2	12.8	11.4
55.0	–	–	–	15.4	16.0	16.4	15.8	15.0	14.0	13.0	12.0	10.6	9.4
60.0	–	–	–	13.0	13.4	14.0	13.6	13.0	12.0	11.0	10.0	9.0	7.6
65.0	–	–	–	10.8	11.4	11.8	11.8	11.2	10.4	9.4	8.6	7.4	6.2
70.0	–	–	–	–	9.6	10.2	10.2	9.8	8.8	8.0	7.2	6.2	5.0
75.0	–	–	–	–	8.2	8.6	8.6	8.4	7.6	6.8	6.0	5.0	3.8
80.0	–	–	–	–	–	7.4	7.4	7.2	6.6	5.8	5.0	4.0	2.8
85.0	–	–	–	–	–	6.2	6.2	6.2	5.6	4.8	4.0	3.2	2.0
90.0	–	–	–	–	–	5.4	5.2	5.2	4.6	4.0	3.2	2.4	–
95.0	–	–	–	–	–	–	4.4	4.2	3.8	3.4	2.6	–	–
100.0	–	–	–	–	–	–	2.0	3.6	3.0	2.6	2.0	–	–
105.0	–	–	–	–	–	–	–	2.8	2.4	1.8	–	–	–
110.0	–	–	–	–	–	–	–	2.2	–	–	–	–	–

THIS CHART IS ONLY A GUIDE AND SHOULD NOT BE USED TO OPERATE THE CRANE.



# Working range

## Swingaway and extensions

197 ft main boom with hydraulic luffing 33 ft and 56 ft swingaway and 1x16 ft insert

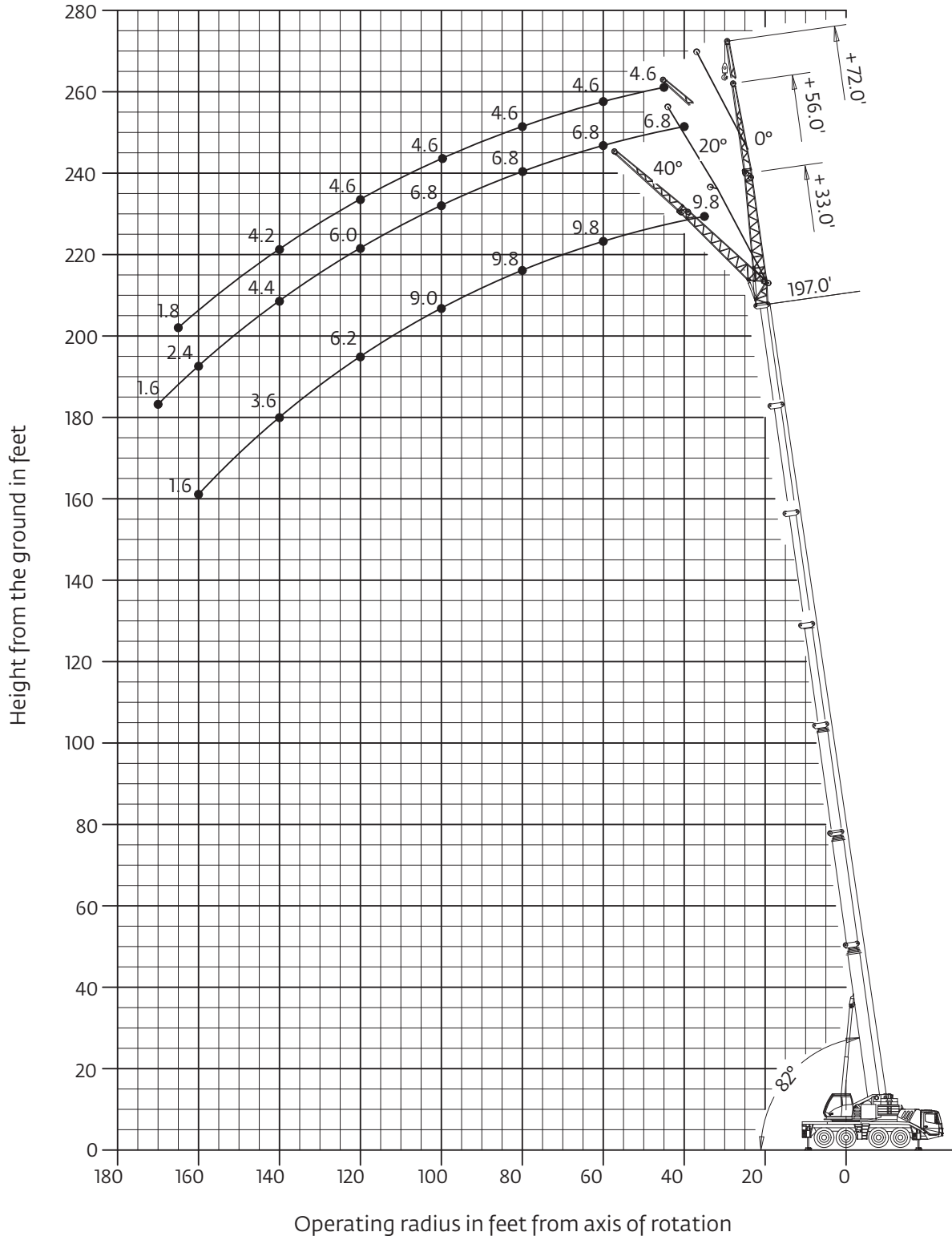

Hook heights shown in the working range diagram do not consider loaded boom deflection.

THIS CHART IS ONLY A GUIDE AND SHOULD NOT BE USED TO OPERATE THE CRANE.

The individual crane's load chart, operating instructions and other instructional plates must be read and understood prior to operating the crane.

# Load charts

## Hydraulic offsettable swingaway

### Intermediate angle



Pounds x 1000

Feet	197 + 33			197 + 56			197 + 72		
	0°	0° - 20°	20° - 40°	0°	0° - 20°	20° - 40°	0°	0° - 20°	20° - 40°
30	—	—	—	—	—	—	—	—	—
35	9.8	—	—	—	—	—	—	—	—
40	9.8	—	—	6.8	—	—	—	—	—
45	9.8	—	—	6.8	—	—	4.6	—	—
50	9.8	—	—	6.8	—	—	4.6	—	—
55	9.8	9.2	—	6.8	—	—	4.6	—	—
60	9.8	9.2	8.8	6.8	—	—	4.6	—	—
65	9.8	9.2	8.8	6.8	—	—	4.6	—	—
70	9.8	9.2	8.8	6.8	6.2	—	4.6	—	—
75	9.8	9.2	8.8	6.8	6.2	—	4.6	4.6	—
80	9.8	9.2	8.8	6.8	6.2	5.4	4.6	4.6	4.6
85	9.8	9.2	8.8	6.8	6.2	5.4	4.6	4.6	4.6
90	9.8	9.2	8.8	6.8	6.2	5.4	4.6	4.6	4.6
95	9.8	9.2	8.8	6.8	6.2	5.4	4.6	4.6	4.6
100	9.0	9.0	8.8	6.8	6.2	5.4	4.6	4.6	4.6
105	8.0	8.0	8.8	6.8	6.2	5.4	4.6	4.6	4.6
110	7.2	7.2	7.8	6.8	6.2	5.4	4.6	4.6	4.6
115	6.4	6.4	7.0	6.6	6.2	5.4	4.6	4.6	4.6
120	5.6	5.6	6.2	6.0	6.0	5.4	4.6	4.6	4.6
125	5.0	5.0	5.6	5.2	5.2	5.4	4.6	4.6	4.6
130	4.4	4.4	4.8	4.6	4.6	5.4	4.4	4.4	4.6
135	3.8	3.8	4.2	4.0	4.0	5.0	3.8	3.8	4.6
140	3.2	3.2	3.6	3.6	3.6	4.4	3.2	3.2	4.2
145	2.6	2.6	3.2	3.0	3.0	4.0	2.8	2.8	3.6
150	2.2	2.2	2.6	2.6	2.6	3.4	2.2	2.2	3.2
155	1.6	1.6	2.0	2.2	2.2	3.0	1.8	1.8	2.6
160	—	—	1.6	1.8	1.8	2.4	—	—	2.2
165	—	—	—	—	—	2.0	—	—	1.8
170	—	—	—	—	—	1.6	—	—	—

### Loads for luffing

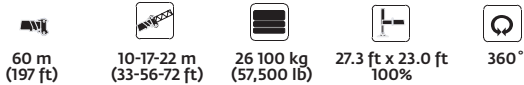

Pounds x 1000





Feet	197 + 33		197 + 56		197 + 72	
	0° - 20°	20° - 40°	0° - 20°	20° - 40°	0° - 20°	20° - 40°
50	—	—	—	—	—	—
55	8.8	—	—	—	—	—
60	8.8	8.4	—	—	—	—
65	8.8	8.4	—	—	—	—
70	8.8	8.4	6.0	—	—	—
75	8.8	8.4	6.0	—	4.4	—
80	8.8	8.4	6.0	5.2	4.4	4.4
85	8.8	8.4	6.0	5.2	4.4	4.4
90	8.8	8.4	6.0	5.2	4.4	4.4
95	8.8	8.4	6.0	5.2	4.4	4.4
100	8.8	8.4	6.0	5.2	4.4	4.4
105	8.0	8.4	6.0	5.2	4.4	4.4
110	7.2	7.8	6.0	5.2	4.4	4.4
115	6.4	7.0	6.0	5.2	4.4	4.4
120	5.6	6.2	6.0	5.2	4.4	4.4
125	5.0	5.6	5.2	5.2	4.4	4.4
130	4.4	4.8	4.6	5.2	4.4	4.4
135	3.8	4.2	4.0	5.0	3.8	4.4
140	3.2	3.6	3.6	4.4	3.2	4.2
145	2.6	3.2	3.0	4.0	2.8	3.6
150	2.2	2.6	2.6	3.4	2.2	3.2
155	1.6	2.0	2.2	3.0	1.8	2.6
160	—	1.6	1.8	2.4	—	2.2
165	—	—	—	2.0	—	1.8
170	—	—	—	1.6	—	—

THIS CHART IS ONLY A GUIDE AND SHOULD NOT BE USED TO OPERATE THE CRANE.

# Load charts

## Hydraulic offsettable swingaway

### Intermediate angle

 60 m (197 ft)  
 10-17-22 m (33-56-72 ft)  
 23 900 kg (52,600 lb)  
 27.3 ft x 23.0 ft 100%  
 360°



Pounds x 1000

Feet	197 + 33			197 + 56			197 + 72		
	0°	0° - 20°	20° - 40°	0°	0° - 20°	20° - 40°	0°	0° - 20°	20° - 40°
30	-	-	-	-	-	-	-	-	-
35	9.8	-	-	-	-	-	-	-	-
40	9.8	-	-	6.8	-	-	-	-	-
45	9.8	-	-	6.8	-	-	4.6	-	-
50	9.8	-	-	6.8	-	-	4.6	-	-
55	9.8	9.2	-	6.8	-	-	4.6	-	-
60	9.8	9.2	8.8	6.8	-	-	4.6	-	-
65	9.8	9.2	8.8	6.8	-	-	4.6	-	-
70	9.8	9.2	8.8	6.8	6.2	-	4.6	-	-
75	9.8	9.2	8.8	6.8	6.2	-	4.6	4.6	-
80	9.8	9.2	8.8	6.8	6.2	5.4	4.6	4.6	4.6
85	9.8	9.2	8.8	6.8	6.2	5.4	4.6	4.6	4.6
90	9.8	9.2	8.8	6.8	6.2	5.4	4.6	4.6	4.6
95	9.0	9.0	8.8	6.8	6.2	5.4	4.6	4.6	4.6
100	8.0	8.0	8.8	6.8	6.2	5.4	4.6	4.6	4.6
105	7.2	7.2	8.0	6.8	6.2	5.4	4.6	4.6	4.6
110	6.4	6.4	7.0	6.6	6.2	5.4	4.6	4.6	4.6
115	5.6	5.6	6.2	5.8	5.8	5.4	4.6	4.6	4.6
120	4.8	4.8	5.4	5.2	5.2	5.4	4.6	4.6	4.6
125	4.2	4.2	4.8	4.6	4.6	5.4	4.2	4.2	4.6
130	3.6	3.6	4.2	4.0	4.0	5.0	3.6	3.6	4.6
135	3.0	3.0	3.6	3.4	3.4	4.4	3.0	3.0	4.2
140	2.4	2.4	3.0	2.8	2.8	3.8	2.6	2.6	3.6
145	2.0	2.0	2.4	2.4	2.4	3.2	2.0	2.0	3.0
150	-	-	2.0	2.0	2.0	2.8	1.6	1.6	2.6
155	-	-	-	1.4	1.4	2.2	-	-	2.0
160	-	-	-	-	-	1.8	-	-	1.6

### Loads for luffing

 60 m (197 ft)  
 10-17-22 m (33-56-72 ft)  
 23 900 kg (52,600 lb)  
 27.3 ft x 23.0 ft 100%  
 360°



Pounds x 1000

Feet	197 + 33		197 + 56		197 + 72	
	0° - 20°	20° - 40°	0° - 20°	20° - 40°	0° - 20°	20° - 40°
50	-	-	-	-	-	-
55	8.8	-	-	-	-	-
60	8.8	8.4	-	-	-	-
65	8.8	8.4	-	-	-	-
70	8.8	8.4	6.0	-	-	-
75	8.8	8.4	6.0	-	4.4	-
80	8.8	8.4	6.0	5.2	4.4	4.4
85	8.8	8.4	6.0	5.2	4.4	4.4
90	8.8	8.4	6.0	5.2	4.4	4.4
95	8.8	8.4	6.0	5.2	4.4	4.4
100	8.0	8.4	6.0	5.2	4.4	4.4
105	7.2	8.0	6.0	5.2	4.4	4.4
110	6.4	7.0	6.0	5.2	4.4	4.4
115	5.6	6.2	5.8	5.2	4.4	4.4
120	4.8	5.4	5.2	5.2	4.4	4.4
125	4.2	4.8	4.6	5.2	4.2	4.4
130	3.6	4.2	4.0	5.0	3.6	4.4
135	3.0	3.6	3.4	4.4	3.0	4.2
140	2.4	3.0	2.8	3.8	2.6	3.6
145	2.0	2.4	2.4	3.2	2.0	3.0
150	-	2.0	2.0	2.8	1.6	2.6
155	-	-	1.4	2.2	-	2.0
160	-	-	-	1.8	-	1.6

THIS CHART IS ONLY A GUIDE AND SHOULD NOT BE USED TO OPERATE THE CRANE.

The individual crane's load chart, operating instructions and other instructional plates must be read and understood prior to operating the crane.

# Load charts

## Manual offsettable swingaway

### Fixed angle



Pounds x 1000

Feet	197 + 33			197 + 56			197 + 72		
	0°	20°	40°	0°	20°	40°	0°	20°	40°
30	-	-	-	-	-	-	-	-	-
35	9.8	-	-	-	-	-	-	-	-
40	9.8	-	-	6.8	-	-	-	-	-
45	9.8	-	-	6.8	-	-	4.6	-	-
50	9.8	9.8	-	6.8	-	-	4.6	-	-
55	9.8	9.8	8.8	6.8	-	-	4.6	-	-
60	9.8	9.8	8.8	6.8	6.8	-	4.6	4.6	-
65	9.8	9.8	8.8	6.8	6.8	-	4.6	4.6	-
70	9.8	9.8	8.8	6.8	6.8	-	4.6	4.6	-
75	9.8	9.8	8.8	6.8	6.8	5.4	4.6	4.6	4.6
80	9.8	9.8	8.8	6.8	6.8	5.4	4.6	4.6	4.6
85	9.8	9.8	8.8	6.8	6.8	5.4	4.6	4.6	4.6
90	9.8	9.8	8.8	6.8	6.8	5.4	4.6	4.6	4.6
95	9.8	9.8	8.8	6.8	6.8	5.4	4.6	4.6	4.6
100	9.0	9.6	8.8	6.8	6.8	5.4	4.6	4.6	4.6
105	8.0	8.8	8.8	6.8	6.8	5.4	4.6	4.6	4.6
110	7.2	7.8	8.4	6.8	6.8	5.4	4.6	4.6	4.6
115	6.4	7.0	7.6	6.6	6.8	5.4	4.6	4.6	4.6
120	5.6	6.2	6.8	6.0	6.6	5.4	4.6	4.6	4.6
125	5.0	5.6	6.0	5.2	6.4	5.4	4.6	4.6	4.6
130	4.4	4.8	5.2	4.6	5.8	5.4	4.4	4.6	4.6
135	3.8	4.2	4.6	4.0	5.0	5.4	3.8	4.6	4.6
140	3.2	3.6	4.0	3.6	4.4	5.2	3.2	4.2	4.6
145	2.6	3.2	3.4	3.0	4.0	4.6	2.8	3.6	4.4
150	2.2	2.6	2.8	2.6	3.4	4.0	2.2	3.2	3.8
155	1.6	2.0	2.2	2.2	3.0	3.4	1.8	2.6	3.2
160	-	1.6	1.8	1.8	2.4	3.0	-	2.2	2.8
165	-	-	-	-	2.0	2.4	-	1.8	2.2
170	-	-	-	-	1.6	2.0	-	-	1.8
175	-	-	-	-	-	1.6	-	-	-

### Fixed angle

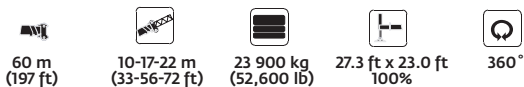

Pounds x 1000

Feet	197 + 33			197 + 56			197 + 72		
	0°	20°	40°	0°	20°	40°	0°	20°	40°
30	-	-	-	-	-	-	-	-	-
35	9.8	-	-	-	-	-	-	-	-
40	9.8	-	-	6.8	-	-	-	-	-
45	9.8	-	-	6.8	-	-	4.6	-	-
50	9.8	9.8	-	6.8	-	-	4.6	-	-
55	9.8	9.8	8.8	6.8	-	-	4.6	-	-
60	9.8	9.8	8.8	6.8	6.8	-	4.6	4.6	-
65	9.8	9.8	8.8	6.8	6.8	-	4.6	4.6	-
70	9.8	9.8	8.8	6.8	6.8	-	4.6	4.6	-
75	9.8	9.8	8.8	6.8	6.8	5.4	4.6	4.6	4.6
80	9.8	9.8	8.8	6.8	6.8	5.4	4.6	4.6	4.6
85	9.8	9.8	8.8	6.8	6.8	5.4	4.6	4.6	4.6
90	9.8	9.8	8.8	6.8	6.8	5.4	4.6	4.6	4.6
95	9.0	9.8	8.8	6.8	6.8	5.4	4.6	4.6	4.6
100	8.0	8.8	8.8	6.8	6.8	5.4	4.6	4.6	4.6
105	7.2	8.0	8.6	6.8	6.8	5.4	4.6	4.6	4.6
110	6.4	7.0	7.6	6.6	6.8	5.4	4.6	4.6	4.6
115	5.6	6.2	6.8	5.8	6.8	5.4	4.6	4.6	4.6
120	4.8	5.4	6.0	5.2	6.4	5.4	4.6	4.6	4.6
125	4.2	4.8	5.2	4.6	5.6	5.4	4.2	4.6	4.6
130	3.6	4.2	4.4	4.0	5.0	5.4	3.6	4.6	4.6
135	3.0	3.6	3.8	3.4	4.4	5.2	3.0	4.2	4.6
140	2.4	3.0	3.2	2.8	3.8	4.4	2.6	3.6	4.4
145	2.0	2.4	2.8	2.4	3.2	3.8	2.0	3.0	3.8
150	-	2.0	2.2	2.0	2.8	3.4	1.6	2.6	3.2
155	-	-	1.6	1.4	2.2	2.8	-	2.0	2.6
160	-	-	-	-	1.8	2.4	-	1.6	2.2
165	-	-	-	-	-	1.8	-	-	1.6

THIS CHART IS ONLY A GUIDE AND SHOULD NOT BE USED TO OPERATE THE CRANE.

# Working range

## Integrated heavy duty jib

38 ft – 197 ft main boom with 10.8 ft integrated heavy duty jib

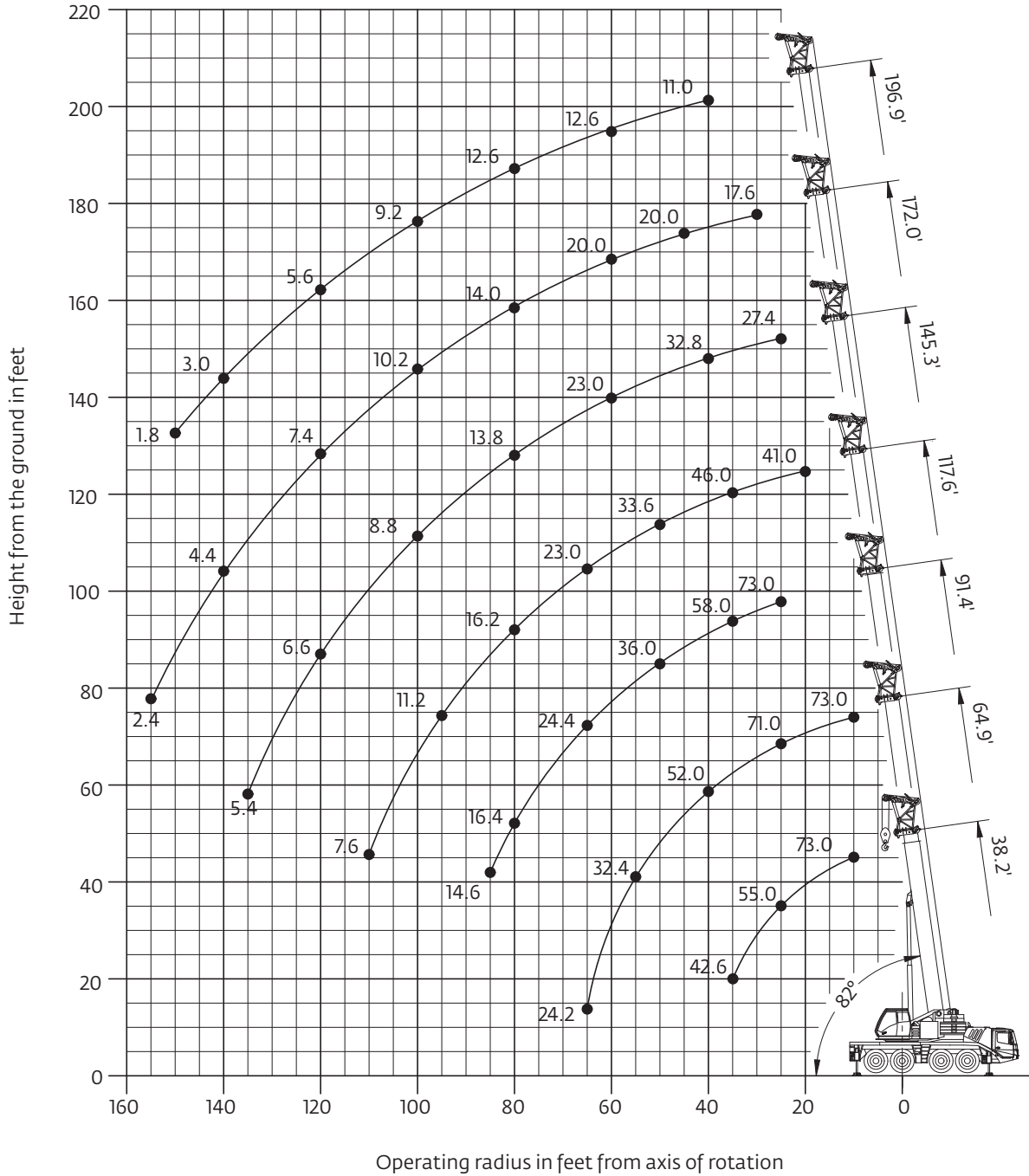







# Load charts

## Integrated heavy duty jib

### Intermediate angle





 11,7 m – 60 m  
(38 ft – 197 ft)
  3,3 m  
(10.8 ft)
  26 100 kg  
(57,500 lb)
  27.3 ft x 23.0 ft  
100%
  360°



Pounds x 1000

Feet	38.2 + 10.8			64.9 + 10.8			91.4 + 10.8			117.6 + 10.8			145.3 + 10.8			172.0 + 10.8			196.9 + 10.8			
	0°	<20°	<40°	0°	<20°	<40°	0°	<20°	<40°	0°	<20°	<40°	0°	<20°	<40°	0°	<20°	<40°	0°	<20°	<40°	
10	73.0	73.0	73.0	—	—	73.0	—	—	—	—	—	—	—	—	—	—	—	—	—	—	—	—
15	71.0	65.0	66.0	—	—	73.0	—	—	—	—	—	—	—	—	—	—	—	—	—	—	—	—
20	60.0	57.0	59.0	73.0	71.0	70.0	—	—	57.0	—	—	41.0	—	—	—	—	—	—	—	—	—	—
25	51.0	51.0	55.0	71.0	65.0	65.0	73.0	68.0	57.0	—	—	41.0	—	—	27.4	—	—	—	—	—	—	—
30	45.0	46.0	—	63.0	59.0	61.0	64.0	64.0	57.0	49.0	46.0	41.0	—	—	27.4	—	—	—	17.6	—	—	—
35	40.2	42.6	—	57.0	55.0	58.0	58.0	57.0	57.0	46.0	43.6	41.0	—	—	27.4	—	—	—	17.6	—	—	—
40	—	—	—	52.0	51.0	52.0	48.0	48.0	49.0	43.2	41.2	41.0	32.8	29.6	27.4	—	—	—	17.6	—	—	11.0
45	—	—	—	44.0	44.0	44.0	41.2	41.2	41.6	38.4	38.6	39.0	32.8	29.6	27.4	20.0	18.0	17.6	—	—	—	11.0
50	—	—	—	37.8	37.8	—	35.6	35.6	36.0	33.2	33.4	33.6	29.8	29.6	27.4	20.0	18.0	17.6	12.6	11.0	11.0	11.0
55	—	—	—	32.4	32.4	—	31.2	31.2	31.4	29.0	29.2	29.4	26.0	26.0	26.2	20.0	18.0	17.6	12.6	11.0	11.0	11.0
60	—	—	—	28.0	—	—	27.4	27.4	27.6	25.6	25.8	26.0	22.6	22.6	23.0	20.0	18.0	17.6	12.6	11.0	11.0	11.0
65	—	—	—	24.2	—	—	24.4	24.4	24.4	22.6	22.8	23.0	20.0	20.0	20.2	19.4	18.0	17.6	12.6	11.0	11.0	11.0
70	—	—	—	—	—	—	21.4	21.4	—	20.2	20.2	20.4	17.6	17.6	17.8	17.2	17.2	17.4	12.6	11.0	11.0	11.0
75	—	—	—	—	—	—	18.8	18.8	—	18.0	18.0	18.2	15.6	15.6	15.6	15.2	15.2	15.4	12.6	11.0	11.0	11.0
80	—	—	—	—	—	—	16.4	16.4	—	16.0	16.2	16.2	13.8	13.8	13.8	13.8	13.8	14.0	12.6	11.0	11.0	11.0
85	—	—	—	—	—	—	14.6	14.6	—	14.2	14.4	14.4	12.2	12.2	12.2	12.4	12.4	12.8	12.6	11.0	11.0	11.0
90	—	—	—	—	—	—	—	—	—	12.6	12.6	—	10.6	10.6	10.8	11.4	11.4	11.8	11.2	11.0	11.0	11.0
95	—	—	—	—	—	—	—	—	—	11.0	11.2	—	9.4	9.4	9.4	10.6	10.8	10.8	10.0	10.2	10.2	10.2
100	—	—	—	—	—	—	—	—	—	9.8	9.8	—	8.6	8.6	8.8	10.0	10.0	10.2	9.0	9.2	9.2	9.2
105	—	—	—	—	—	—	—	—	—	8.6	8.6	—	8.0	8.0	8.2	9.2	9.4	9.4	8.0	8.2	8.2	8.2
110	—	—	—	—	—	—	—	—	—	7.4	7.6	—	7.6	7.6	7.6	8.6	8.8	8.8	7.0	7.2	7.2	7.2
115	—	—	—	—	—	—	—	—	—	—	—	—	7.0	7.0	—	8.2	8.2	8.2	6.2	6.4	6.4	6.4
120	—	—	—	—	—	—	—	—	—	—	—	—	6.6	6.6	—	7.4	7.4	7.4	5.4	5.6	5.6	5.6
125	—	—	—	—	—	—	—	—	—	—	—	—	6.2	6.2	—	6.6	6.6	6.6	4.8	5.0	5.0	5.0
130	—	—	—	—	—	—	—	—	—	—	—	—	5.8	5.8	—	5.8	5.8	5.8	4.2	4.2	4.2	4.4
135	—	—	—	—	—	—	—	—	—	—	—	—	5.4	2.0	—	5.0	5.0	—	3.4	3.6	3.6	3.6
140	—	—	—	—	—	—	—	—	—	—	—	—	—	—	—	4.4	4.4	—	2.8	3.0	3.0	3.0
145	—	—	—	—	—	—	—	—	—	—	—	—	—	—	—	3.8	3.8	—	2.2	2.4	2.4	2.4
150	—	—	—	—	—	—	—	—	—	—	—	—	—	—	—	3.4	3.4	—	1.8	1.8	1.8	1.8
155	—	—	—	—	—	—	—	—	—	—	—	—	—	—	—	2.8	2.8	—	—	—	—	—
160	—	—	—	—	—	—	—	—	—	—	—	—	—	—	—	2.4	—	—	—	—	—	—

### Loads for luffing

 11,7 m – 60 m  
(38 ft – 197 ft)
  3,3 m  
(10.8 ft)
  26 100 kg  
(57,500 lb)
  27.3 ft x 23.0 ft  
100%
  360°



Pounds x 1000

Feet	38.2 + 10.8		64.9 + 10.8		91.4 + 10.8		117.6 + 10.8		145.3 + 10.8		172.0 + 10.8		196.9 + 10.8	
	0° - 20°	20 - 40°	0° - 20°	20 - 40°	0° - 20°	20 - 40°	0° - 20°	20 - 40°	0° - 20°	20 - 40°	0° - 20°	20 - 40°	0° - 20°	20 - 40°
10	46.0	46.0	—	48.0	—	—	—	—	—	—	—	—	—	—
15	43.4	44.0	—	46.0	—	—	—	—	—	—	—	—	—	—
20	40.6	43.0	45.0	45.0	—	46.0	—	39.0	—	—	—	—	—	—
25	38.6	42.8	43.8	44.0	45.0	45.0	—	39.0	—	26.0	—	—	—	—
30	37.2	—	41.8	43.2	45.0	45.0	43.8	39.0	—	26.0	—	17.2	—	—
35	36.6	—	40.2	42.8	43.8	44.0	41.6	39.0	—	26.0	—	17.2	—	—
40	—	—	38.8	42.6	42.4	43.4	39.2	39.0	29.6	26.0	—	17.2	—	11.0
45	—	—	37.8	41.6	41.0	41.6	36.8	37.6	29.6	26.0	18.0	17.2	—	11.0
50	—	—	34.8	—	35.0	35.2	33.4	33.6	29.0	26.0	18.0	17.2	10.8	11.0
55	—	—	29.6	—	29.8	30.0	29.2	29.4	26.0	26.0	18.0	17.2	10.8	11.0
60	—	—	—	—	25.8	25.8	25.6	25.8	22.6	23.0	18.0	17.2	10.8	11.0
65	—	—	—	—	22.4	22.4	22.2	22.4	20.0	20.2	18.0	17.2	10.8	11.0
70	—	—	—	—	19.6	—	19.4	19.4	17.6	17.8	17.2	17.2	10.8	11.0
75	—	—	—	—	17.2	—	17.0	17.0	15.6	15.6	15.2	15.4	10.8	11.0
80	—	—	—	—	15.2	—	15.0	15.0	13.6	13.8	13.6	13.6	10.8	11.0
85	—	—	—	—	13.4	—	13.2	13.2	11.8	12.0	12.0	12.2	10.8	11.0
90	—	—	—	—	—	—	11.8	—	10.4	10.4	11.0	11.2	10.8	11.0
95	—	—	—	—	—	—	10.4	—	9.0	9.0	10.2	10.4	10.2	10.2
100	—	—	—	—	—	—	9.2	—	8.2	8.4	9.6	9.6	9.2	9.2
105	—	—	—	—	—	—	8.0	—	7.8	7.8	8.8	9.0	8.2	8.2
110	—	—	—	—	—	—	7.2	—	7.2	7.2	8.4	8.4	7.2	7.2
115	—	—	—	—	—	—	—	—	6.8	—	7.8	7.8	6.4	6.4
120	—	—	—	—	—	—	—	—	6.4	—	6.8	7.0	5.6	5.6
125	—	—	—	—	—	—	—	—	6.0	—	6.2	6.2	5.0	5.0
130	—	—	—	—	—	—	—	—	5.6	—	5.4	5.4	4.2	4.2
135	—	—	—	—	—	—	—	—	2.0	—	4.8	—	3.6	3.6
140	—	—	—	—	—	—	—	—	—	—	4.2	—	3.0	3.0
145	—	—	—	—	—	—	—	—	—	—	3.8	—	2.4	2.4
150	—	—	—	—	—	—	—	—	—	—	3.2	—	1.8	1.8
155	—	—	—	—	—	—	—	—	—	—	2.8	—	—	—

THIS CHART IS ONLY A GUIDE AND SHOULD NOT BE USED TO OPERATE THE CRANE.

# Load charts

## Integrated heavy duty jib

### Intermediate angle

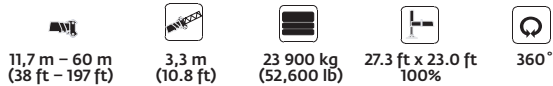

Pounds x 1000

Feet	38.2 + 10.8			64.9 + 10.8			91.4 + 10.8			117.6 + 10.8			145.3 + 10.8			172.0 + 10.8			196.9 + 10.8			
	0°	<20°	<40°	0°	<20°	<40°	0°	<20°	<40°	0°	<20°	<40°	0°	<20°	<40°	0°	<20°	<40°	0°	<20°	<40°	
10	73.0	73.0	73.0	-	-	73.0	-	-	-	-	-	-	-	-	-	-	-	-	-	-	-	-
15	71.0	65.0	66.0	-	-	73.0	-	-	-	-	-	-	-	-	-	-	-	-	-	-	-	-
20	60.0	57.0	59.0	73.0	71.0	70.0	-	-	57.0	-	-	41.0	-	-	-	-	-	-	-	-	-	-
25	51.0	51.0	55.0	71.0	65.0	65.0	73.0	68.0	57.0	-	-	41.0	-	-	27.4	-	-	-	-	-	-	-
30	45.0	46.0	-	63.0	59.0	61.0	64.0	64.0	57.0	49.0	46.0	41.0	-	-	27.4	-	-	-	-	-	-	-
35	40.2	42.6	-	57.0	55.0	58.0	55.0	55.0	55.0	46.0	43.6	41.0	-	-	27.4	-	-	17.6	-	-	-	-
40	-	-	-	49.0	49.0	50.0	46.0	46.0	46.0	42.4	41.2	41.0	32.8	29.6	27.4	-	-	17.6	-	-	-	11.0
45	-	-	-	41.8	41.8	42.0	39.0	39.0	39.4	36.2	36.4	36.8	32.4	29.6	27.4	20.0	18.0	17.6	-	-	-	11.0
50	-	-	-	35.8	35.8	-	33.6	33.6	34.0	31.4	31.4	31.8	28.0	28.0	27.4	20.0	18.0	17.6	12.6	11.0	11.0	11.0
55	-	-	-	30.4	30.4	-	29.2	29.2	29.6	27.2	27.4	27.6	24.2	24.2	24.4	20.0	18.0	17.6	12.6	11.0	11.0	11.0
60	-	-	-	26.0	-	-	25.8	25.8	26.0	24.0	24.0	24.2	21.0	21.0	21.4	20.0	18.0	17.6	12.6	11.0	11.0	11.0
65	-	-	-	22.6	-	-	22.6	22.6	22.8	21.2	21.2	21.4	18.4	18.4	18.6	18.0	18.0	17.6	12.6	11.0	11.0	11.0
70	-	-	-	-	-	-	19.8	19.8	-	18.8	18.8	19.0	16.2	16.2	16.4	15.8	15.8	16.0	12.6	11.0	11.0	11.0
75	-	-	-	-	-	-	17.2	17.2	-	16.6	16.8	16.8	14.2	14.2	14.4	14.8	14.8	15.0	12.6	11.0	11.0	11.0
80	-	-	-	-	-	-	15.2	15.2	-	14.8	15.0	15.0	12.4	12.4	12.6	13.8	13.8	14.0	12.6	11.0	11.0	11.0
85	-	-	-	-	-	-	13.2	13.2	-	13.0	13.0	13.0	11.0	11.0	11.0	12.4	12.4	12.8	11.4	11.0	11.0	11.0
90	-	-	-	-	-	-	-	-	-	11.4	11.4	-	10.0	10.0	10.0	11.4	11.4	11.8	10.2	10.4	10.4	10.4
95	-	-	-	-	-	-	-	-	-	9.8	10.0	-	9.2	9.2	9.4	10.6	10.8	10.8	9.0	9.2	9.2	9.2
100	-	-	-	-	-	-	-	-	-	8.6	8.8	-	8.6	8.6	8.8	10.0	10.0	10.2	8.0	8.2	8.2	8.2
105	-	-	-	-	-	-	-	-	-	7.6	7.6	-	8.0	8.0	8.2	9.2	9.2	9.2	7.0	7.2	7.2	7.2
110	-	-	-	-	-	-	-	-	-	6.8	6.8	-	7.6	7.6	7.6	8.2	8.2	8.2	6.2	6.4	6.4	6.4
115	-	-	-	-	-	-	-	-	-	-	-	-	7.0	7.0	-	7.4	7.4	7.4	5.4	5.6	5.6	5.6
120	-	-	-	-	-	-	-	-	-	-	-	-	6.6	6.6	-	6.4	6.4	6.4	4.6	4.8	4.8	4.8
125	-	-	-	-	-	-	-	-	-	-	-	-	6.2	6.2	-	5.6	5.6	5.6	4.0	4.2	4.2	4.2
130	-	-	-	-	-	-	-	-	-	-	-	-	5.8	5.8	-	5.0	5.0	5.0	3.4	3.6	3.6	3.6
135	-	-	-	-	-	-	-	-	-	-	-	-	5.4	-	-	4.4	4.4	-	2.6	2.8	2.8	2.8
140	-	-	-	-	-	-	-	-	-	-	-	-	-	-	-	3.8	3.8	-	2.0	2.2	2.2	2.2
145	-	-	-	-	-	-	-	-	-	-	-	-	-	-	-	3.2	3.2	-	1.6	1.6	1.6	1.6
150	-	-	-	-	-	-	-	-	-	-	-	-	-	-	-	2.6	2.6	-	-	-	-	-
155	-	-	-	-	-	-	-	-	-	-	-	-	-	-	-	2.2	2.2	-	-	-	-	-
160	-	-	-	-	-	-	-	-	-	-	-	-	-	-	-	1.6	-	-	-	-	-	-

### Loads for luffing

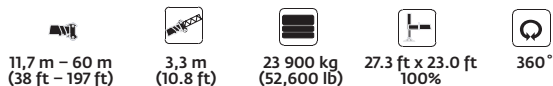

Pounds x 1000

Feet	38.2 + 10.8		64.9 + 10.8		91.4 + 10.8		117.6 + 10.8		145.3 + 10.8		172.0 + 10.8		196.9 + 10.8	
	0° - 20°	20° - 40°	0° - 20°	20° - 40°	0° - 20°	20° - 40°	0° - 20°	20° - 40°	0° - 20°	20° - 40°	0° - 20°	20° - 40°	0° - 20°	20° - 40°
10	46.0	46.0	-	48.0	-	-	-	-	-	-	-	-	-	-
15	43.4	44.0	-	46.0	-	-	-	-	-	-	-	-	-	-
20	40.6	43.0	45.0	45.0	-	46.0	-	39.0	-	-	-	-	-	-
25	38.6	42.8	43.8	44.0	45.0	45.0	-	39.0	-	26.0	-	-	-	-
30	37.2	-	41.8	43.2	45.0	45.0	43.8	39.0	-	26.0	-	17.2	-	-
35	36.6	-	40.2	42.8	43.8	44.0	41.6	39.0	-	26.0	-	17.2	-	-
40	-	-	38.8	42.6	42.4	43.4	39.2	39.0	29.6	26.0	-	17.2	-	11.0
45	-	-	37.8	39.2	39.0	39.4	36.4	36.8	29.6	26.0	18.0	17.2	-	11.0
50	-	-	32.8	-	33.0	33.2	31.4	31.8	28.0	26.0	18.0	17.2	10.8	11.0
55	-	-	28.0	-	28.0	28.2	27.4	27.6	24.2	24.4	18.0	17.2	10.8	11.0
60	-	-	-	-	24.2	24.2	24.0	24.2	21.0	21.4	18.0	17.2	10.8	11.0
65	-	-	-	-	21.0	21.0	20.8	20.8	18.4	18.6	18.0	17.2	10.8	11.0
70	-	-	-	-	18.2	-	18.0	18.2	16.2	16.4	15.8	16.0	10.8	11.0
75	-	-	-	-	16.0	-	15.8	15.8	14.2	14.4	14.0	14.4	10.8	11.0
80	-	-	-	-	14.0	-	13.8	14.0	12.4	12.6	13.0	13.4	10.8	11.0
85	-	-	-	-	12.4	-	12.2	12.2	10.8	11.0	11.8	12.2	10.8	11.0
90	-	-	-	-	-	-	10.8	-	9.6	9.6	11.0	11.2	10.4	11.0
95	-	-	-	-	-	-	9.4	-	8.8	9.0	10.2	10.4	9.2	10.4
100	-	-	-	-	-	-	8.2	-	8.2	8.4	9.6	9.6	8.2	9.2
105	-	-	-	-	-	-	7.2	-	7.8	7.8	8.8	8.8	7.2	8.2
110	-	-	-	-	-	-	6.6	-	7.2	7.2	7.8	7.8	6.4	7.2
115	-	-	-	-	-	-	-	-	6.8	-	7.0	7.0	5.6	6.4
120	-	-	-	-	-	-	-	-	6.4	-	6.2	6.2	4.8	5.6
125	-	-	-	-	-	-	-	-	6.0	-	5.4	5.4	4.2	4.8
130	-	-	-	-	-	-	-	-	5.6	-	4.8	4.8	3.6	4.2
135	-	-	-	-	-	-	-	-	-	-	4.2	-	2.8	3.6
140	-	-	-	-	-	-	-	-	-	-	3.6	-	2.2	2.8
145	-	-	-	-	-	-	-	-	-	-	3.2	-	1.6	2.2
150	-	-	-	-	-	-	-	-	-	-	2.6	-	-	1.6
155	-	-	-	-	-	-	-	-	-	-	2.2	-	-	-



# Notes

# Symbols glossary



Axles



Counterweight



Grade



Outriggers



Boom



Drive



Heavy duty jib



Radius



Boom elevation



Electrical system



Hoist



Rotation



Boom extension



Engine



Hookblock



Speed



Boom length



Extension



Hydraulic system



Steering



Boom nose



Frame



Lights



Suspension



Brakes



Fuel tank capacity



Oil



Swing



Cab



Gear



Outrigger controls



Tires



Transmission



## Manitowoc Cranes

### Regional headquarters

#### Americas

**Manitowoc, Wisconsin, USA**

Tel: +1 920 684 6621

Fax: +1 920 683 6277

**Shady Grove, Pennsylvania, USA**

Tel: +1 717 597 8121

Fax: +1 717 597 4062

#### Europe, Middle East, Africa

**Ecully, France**

Tel: +33 (0)4 72 18 20 20

Fax: +33 (0)4 72 18 20 00

#### China

**Shanghai, China**

Tel: +86 21 6457 0066

Fax: +86 21 6457 4955

#### Greater Asia-Pacific

**Singapore**

Tel: +65 6264 1188

Fax: +65 6862 4040

### Regional offices

#### Americas

**Brazil**

Alphaville

**Mexico**

Monterrey

**Chile**

Santiago

#### Europe, Middle East,

**Africa**

**Czech Republic**

Netvorice

**France**

Baudemont

Cergy

Decines

**Germany**

Langenfeld

**Hungary**

Budapest

**Italy**

Lainate

**Netherlands**

Breda

**Poland**

Warsaw

**Portugal**

Baltar

**Russia**

Moscow

**South Africa**

Johannesburg

**U.A.E.**

Dubai

**U.K.**

Buckingham

#### China

Beijing

Chengdu

Guangzhou

Xian

#### Greater Asia-Pacific

**Australia**

Brisbane

Melbourne

Sydney

**India**

Chennai

Delhi

Hyderabad

Pune

**Korea**

Seoul

**Philippines**

Makati City

**Singapore**

### Factories

**Brazil**

Passo Fundo

**China**

TaiAn

Zhangjiagang

**France**

Charlieu

Moulins

**Germany**

Wilhelmshaven

**India**

Pune

**Italy**

Niella Tanaro

**Portugal**

Baltar

Fânzeres

**Slovakia**

Saris

**USA**

Manitowoc

Port Washington

Shady Grove

This document is non-contractual. Constant improvement and engineering progress make it necessary that we reserve the right to make specification, equipment, and price changes without notice. Illustrations shown may include optional equipment and accessories and may not include all standard equipment.