

# Grove RT700E

## Product Guide



### Features

- 50 t - 55 t (50 USt - 60 USt) capacity
- 11 m – 33,5 m (36 ft – 110 ft) four-section full power boom
- 10,1 m (33 ft) offsettable lattice swingaway extension
- 10,1 m - 17,1 m (33 ft - 56 ft) bi-fold lattice swingaway extension
- 6,1 m (20 ft) or 12,2 m (40 ft) extension inserts
- 5553 kg (12,242 lb) counterweight pinned to superstructure
- 179 kW (240 bhp) Tier III Cummins diesel engine



# Features

## MEGAFORM™ boom

The superstructure features a full-power four-section MEGAFORM™ boom that can reach to a maximum tip height of 119 ft. The sequence synchronized extension features telescopic boom sections via a single lever joystick controller.



## Grove “E” Series cab

The Grove “E” Series cab includes hot water heater/defroster, air conditioning, single axis joystick controllers, sliding skylight and adjustable sunscreen, engine instrumentation, full acoustical lining, and a large open stowage compartment for tools and rigging accessories. The “E” Series cab also features the PAT IFlex 5 graphic display LMI which includes a work area definition system to allow the operator to define a preferred working area.



## Smooth operation

The RT700E has a quick-reeve boom nose and swingaway alignment device to help operators set up smoothly.



## Extensions

An optional bi-fold swingaway lattice extension easily stows on the side of the base boom for easy transport while providing on-board extension from 33 ft - 56 ft for a maximum tip height of 174.5 ft. By adding inserts of 20 ft or 40 ft, the maximum tip height on the RT700E can be extended even further to 194 ft or 214 ft.

An optional 33 ft fixed swingaway is also available with a maximum tip height of 150 ft.

# Contents

Specifications	4
Dimensions and weights	7
Working range: Bi-fold swingaway	8
Load charts	9
Working range: Bi-fold swingaway and inserts	12
Load charts	13
Load handling	17

# Specifications

## Superstructure

### Boom

11 m - 33,5 m (36 ft - 110 ft) four-section, full-power sequenced synchronized boom.

Maximum tip height: 36,4 m (119 ft).

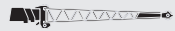

### \*Optional fixed swingaway extension

10,1 m (33 ft) offsettable lattice swingaway extension. Offsettable at 0°, 25° and 45°. Stows alongside base boom section.

Maximum tip height: 45,8 m (150 ft).



### \*Optional bi-fold swingaway extension

10,1 m - 17,1 m (33 ft - 56 ft) bi-fold lattice swingaway extension. Offsettable at 0°, 25° and 45°. Stows alongside base boom section. Maximum tip height: 53,2 m (174.5 ft).



### \*Optional 6,1 m (20 ft) or 12,2 m (40 ft) inserts

Installs between boom nose and bi-fold extension, non-stowable. Maximum tip height: 59,1 m (194 ft) with 20 ft insert, 65,2 m (214 ft) with 40 ft insert.



### Boom nose

Three nylatron sheaves (four with 60 USt rating) mounted on heavy-duty tapered roller bearings with removable pin-type rope guards. Quick-reeve type boom nose.

\*Optional removable auxiliary boom nose with removable pin type rope guard.



### Boom elevation

One double-acting hydraulic cylinder with integral holding valve provides elevation from -3° to 78°.



### Load moment and anti-two block system

Standard "Graphic Display" load moment and anti-two block system with audio-visual warning and control lever lockout. These systems provide electronic display of boom angle, length, radius, tip height, relative load moment, maximum permissible load, load indication and warning of impending two-block condition. The standard Work Area Definition System allows the operator to pre-select and define safe working areas. If the crane approaches the pre-set limits, audio-visual warnings aid the operator in avoiding job-site obstructions.



### Cab

Full-vision, all-steel fabricated with acoustical lining and tinted safety glass throughout. Deluxe seat incorporates armrest-mounted hydraulic single-axis controllers. Dash panel incorporates gauges for all engine functions. Other standard features include: hot water heater, air-conditioning, cab circulating air fan, sliding side and rear windows, sliding skylight with electric wiper and sunscreen, electric windshield wash/wipe, fire extinguisher and seat belt.



### Swing

Planetary swing with foot-applied multi-disc brake. Spring applied, hydraulically-released swing brake and plunger-type, one position, mechanical house lock operated from cab. \*Optional 360° mechanical swing lock. Maximum speed: 2.5 rpm.



### Counterweight

5835 kg (12,865 lb) pinned to superstructure.



### Hydraulic system

Three main gear pumps with a combined capacity of 391 LPM (103 GPM), 511 LPM (135 GPM) with optional air conditioning.

Maximum operating pressure: 27,6 MPa (4000 psi). Two individual post pressure compensated valve banks.

Return line type filter with full flow by-pass protection and service indicator. Replaceable cartridge with micron filtration rating of 5/12/16. 500 L (132 gallon) reservoir. Integral oil cooler. System pressure test ports.



### Hoist Specifications (GHP30A-18G) main and auxiliary hoist

Main and auxiliary hoist: Model GHP30A-18G

Planetary reduction with automatic spring applied multi-disc brake. Grooved drum. Electronic hoist drum rotation indicator and hoist drum cable followers.

Maximum single line pull: 8246 kg (20,250 lb)

Maximum single line speed: 179 m/min (542 fpm)

Maximum permissible line pull:

7620 kg (16,800 lb) with standard 6 x 37 class rope

7620 kg (16,800 lb) with optional 35 x 7 class rope

# Specifications

## Superstructure continued

Rope diameter: 19 mm (3/4 in)

Rope length: 152 m (500 ft)

\*Optional 168 m (550 ft) 35 x 7 class rope

Rope type: 6 x 37 class EIPS IWRC

\*Optional 35 x 7 class rotation resistant

Maximum rope stowage: 256 m (841 ft).

## Carrier



### Chassis

Box section frame fabricated from high-strength, low alloy steel. Integral outrigger housings and front/rear towing, lifting, and tie down lugs.



### Outrigger system

Four hydraulic telescoping single-stage double box beam outriggers with inverted jacks and integral holding valves. Three position settings, 100%, 50% and fully retracted. All steel fabricated, quick-release type round outrigger floats, 610 mm (24 in) diameter. Maximum outrigger pad load: 36 606 kg (80,700 lb).



### Outrigger controls

Controls and crane level indicator located in cab.



### Engine (Tier III)

Cummins QSB 6.7 L diesel, six cylinders, turbocharged, 179 kW (240 bhp) (Gross) @ 2500 rpm. Maximum torque: 987 N-m (728 ft lb) @ 1 500 rpm.



### Engine (Tier IV)

Cummins QSB 6.7 L diesel, six cylinders, turbocharged with Cummins Diesel Particulate Exhaust filter/muffler. Meets emissions per U.S.E.P.A. Tier IV and E.U. Stage III B. 179 kW (240 bhp) at 2500 rpm. Maximum torque: 990 N-m (730 ft lb) at 1500 rpm.

Fuel requirement: Maximum of 15 ppm sulphur content (Ultra Low Diesel Fuel).

**Note:** Tier IV engine Required in North American and European Union countries.



### Fuel tank capacity

273 L (72 gal)



### Transmission

Spicer powershift with 6 forward and 6 reverse speeds (3 speeds high and 3 speeds low). Front axle disconnect for 4 x 2 travel.



### Electrical system

Two 12-volt maintenance free batteries. 12-volt starting and lighting, circuit breakers, battery disconnect switch.



### Drive

4 x 4



### Steering

Fully independent power steering:

Front: Full hydraulic, steering wheel controlled.

Rear: Full hydraulic, switch controlled.

Provides infinite variations of 4 main steering modes: front only, rear only, crab and coordinated.

Rear steer centered indicating light.

4 wheel turning radius - 6,7 m (22 ft 2 in).



### Axles

**Front:** Drive/steer with differential and planetary reduction hubs rigid-mounted to frame.

**Rear:** Drive/steer with differential and planetary reduction hubs pivot-mounted to frame.

Automatic full hydraulic lockouts on rear axle permit 203 mm (8 in) oscillation only with boom centered over the front.



### Brakes

Full hydraulic split circuit brakes operating on all wheels. Spring-applied, hydraulically released axle-mounted parking brake.

# Specifications

## Carrier continued

### Tires

29.5 x 25 - 28PR bias earthmover type.

### Lights

Full lighting package including turn indicators, head, tail, brake and hazard warning lights.

### Maximum speed

37 km/h (23 mph).

### Gradeability (theoretical)

75% (Based on 40 802 kg [89,951 lb] GVW) 29.5 x 25 tires, pumps engaged, 33,6 m (110 ft) boom, bi-fold extension, aux. hoist and cable, and 60 USt hook block.

## Miscellaneous standard equipment

Full width steel fenders with full aluminum decking, dual rear view mirrors, hook block tiedown, electronic back-up alarm, light package, front stowage well, tachometer, rear wheel position indicator, 36,000 BTU hot water heater, air conditioning package with 28,500 BTU hydraulic driven air conditioning, hoist mirrors, engine distress A/V warning system. Auxiliary hoist control valve arrangement (less hoist). Cold start aid and immersion type engine block heater, 120V 1500 watt.

## \* Optional equipment

- ▶ **Auxiliary Hoist Package:** Includes Model GHP30A-18G auxiliary hoist with electronic hoist drum rotation indicator, hoist drum cable follower, 152 m (500 ft) of 19 mm (3/4 in) 35 X 7 class wire rope, auxiliary single sheave boom nose.
- ▶ **Auxiliary Light and Convenience Package:** Includes cab mounted amber flashing light, in-cab LMI light bar, 360° rotation spotlight and dual base boom mounted floodlights, rubber mat for stowage trough
- ▶ “CE” Mark Conformance (sound abatement foam kits, 3rd wrap indicator, emergency auxiliary steering, dual axis joystick controllers)
- ▶ Cross axle differential locks (front and rear)
- ▶ Manual pump disconnect
- ▶ Pintle hook - rear
- ▶ 360° NYC style positive swinglock
- ▶ PAT event recorder
- ▶ Hydraulic removable counterweight

# Dimensions and weights

## Dimensions

Tire size	A	B	C	D	E	F	G	A	B	C	D	E	F	G
29.5 X 25	14 867 mm (585")	15 368 mm (605")	12 460 mm (491")	11 732 mm (462")	11 342 mm (446")	9004 mm (355")	7662 mm (302")	10 809 mm (426")	11 153 mm (439")	7830 mm (308")	7099 mm (280")	6744 mm (266")	4368 mm (172")	3496 mm (138")
<b>2 Wheel Steer</b>								<b>4 Wheel Steer</b>						

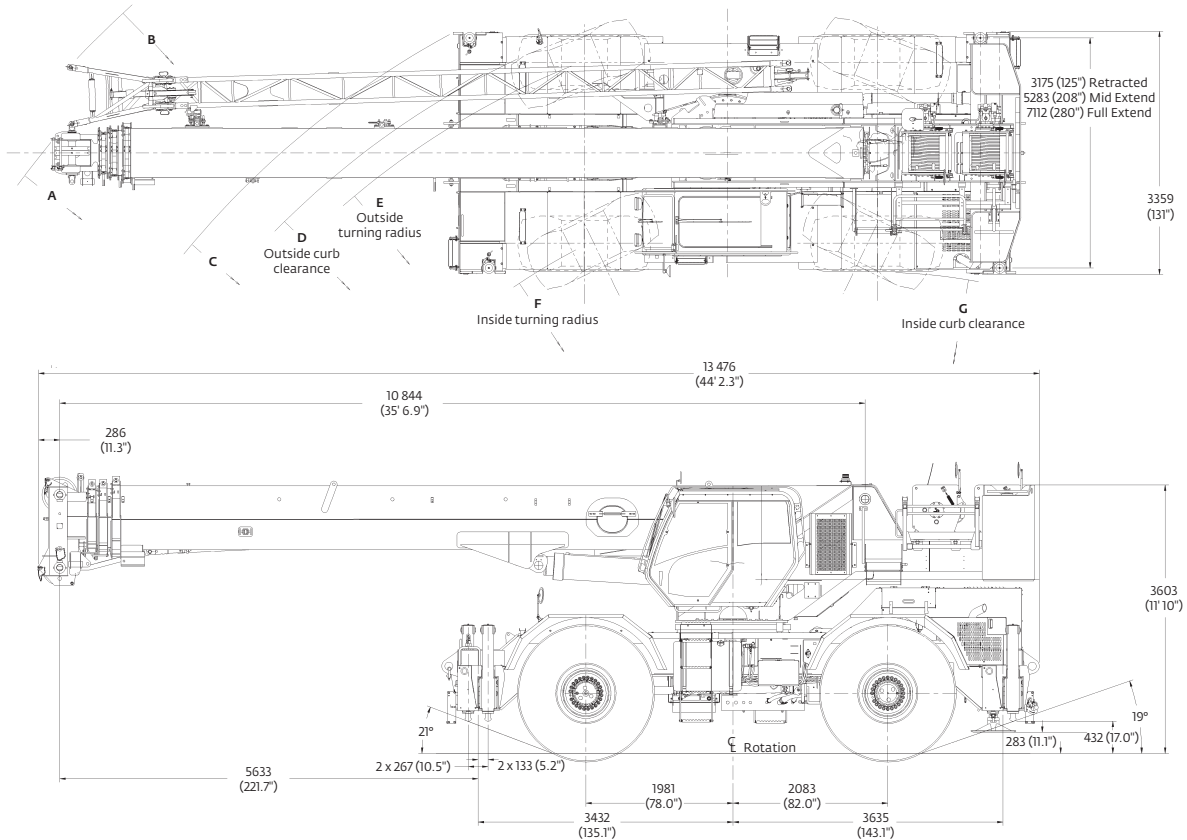

## Weights

	GVW		Front		Rear	
	kg	(lb)	kg	(lb)	kg	(lb)
<b>Basic machine:</b> Including 110 ft main boom, main hoist with 500 ft of wire rope, IPO, full pinned counterweight, full alum. Decking, A/C, and hoist access platform	38 735	(85,394)	18 809	(41,466)	19 926	(43,928)
<b>ADD:</b> 33 ft -56 ft bi-fold swingaway + extension carrier brackets	1265	(2788)	1997	(4402)	-732	(-1614)
<b>ADD:</b> Auxiliary Boom Nose	59	(131)	171	(377)	-112	(-247)
<b>ADD:</b> 45 t (50 USt) 3-sheave hook block stowed in trough	458	(1010)	458	(1010)	0	(0)
<b>ADD:</b> 55 t (60 USt) 5-sheave hook block stowed in trough	580	(1280)	580	(1280)	0	(0)
<b>ADD:</b> 7.5 t (8.3 USt) headache ball tied to O/R cable	161	(355)	262	(578)	-101	(-223)
<b>Remove:</b> Hydraulic removal counterweight	-6042	(-13,320)	206	(4550)	-8106	(-17,870)

# Working range

110 ft main boom and 33 ft - 56 ft bi-fold swingaway

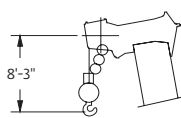
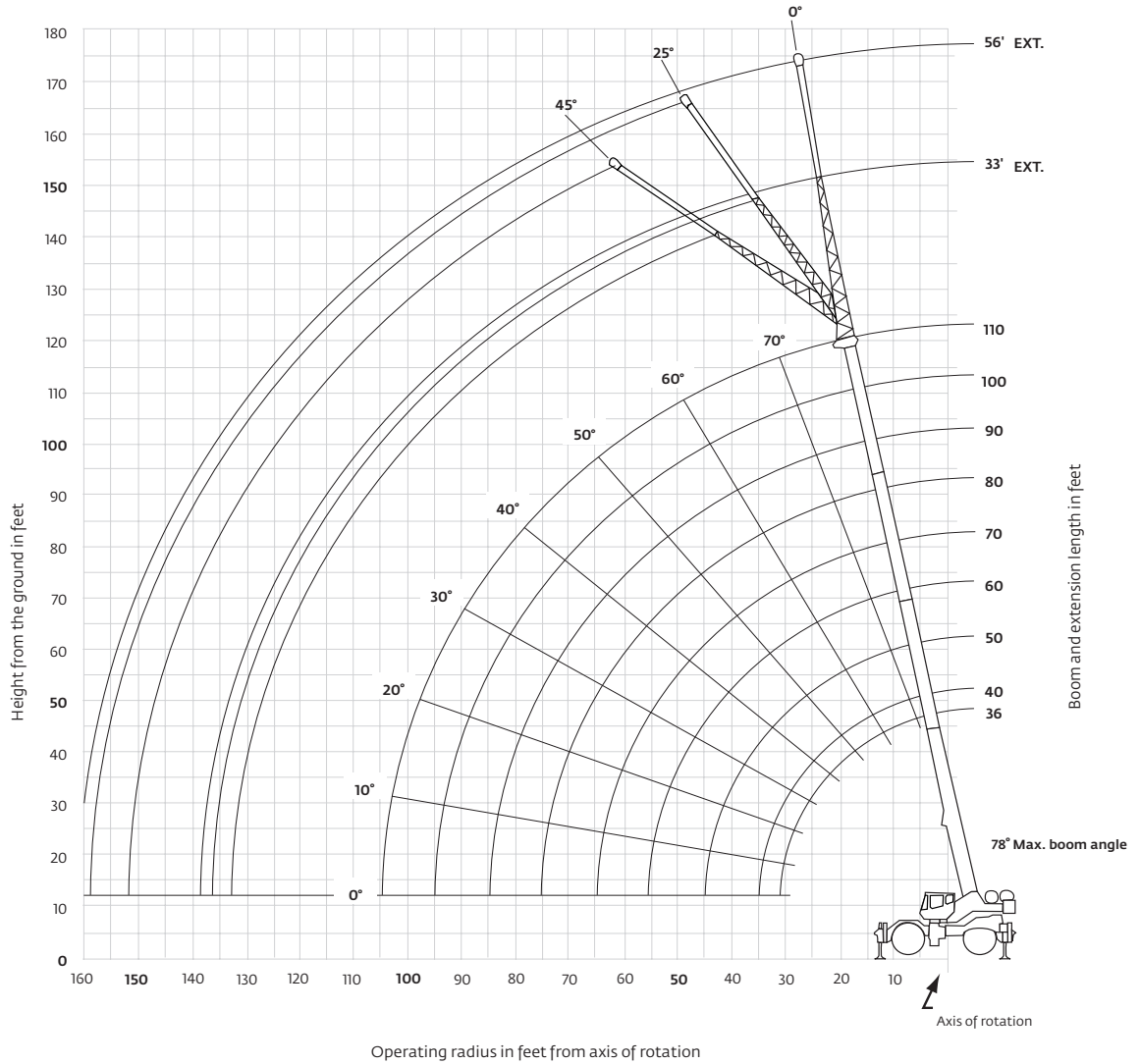

Dimensions are for largest Grove furnished hookblock and headache ball, with anti-two block activated.



# Load chart RT750E

 36 ft - 110 ft    
  12,865 lb    
  100%    
  360°

23 ft 4 in spread

Feet	36	40	50	**60	70	80	90	100	110
10	100,000 (69)	84,400 (72)	80,200 (76)	*62,500 (78)					
12	100,000 (65.5)	84,400 (68.5)	80,200 (73.5)	62,500 (77)	*36,800 (78)				
15	85,400 (59.5)	82,700 (63.5)	80,200 (70)	61,000 (74)	36,800 (76.5)	*36,800 (78)	*31,000 (78)		
20	65,700 (49)	65,000 (55)	64,300 (63.5)	50,650 (69)	36,800 (72)	36,800 (75)	31,000 (77)	*29,100 (78)	*24,000 (78)
25	52,800 (36)	52,450 (45)	51,850 (56.5)	41,800 (63.5)	36,800 (68)	34,000 (71)	30,000 (73.5)	27,000 (76)	24,000 (77.5)
30		42,150 (31.5)	39,600 (48.5)	38,000 (57.5)	33,400 (63)	29,000 (67)	25,300 (70.5)	24,200 (72.5)	22,000 (75)
35			31,750 (40)	29,750 (51.5)	28,700 (58)	25,000 (63)	22,200 (67)	21,750 (69.5)	20,000 (72)
40			24,450 (28)	24,750 (45)	23,600 (53)	22,000 (59)	20,200 (63)	19,000 (66.5)	18,500 (69)
45				19,750 (37)	19,700 (47.5)	18,800 (54.5)	17,800 (59.5)	17,300 (63)	17,300 (66.5)
50				16,000 (26.5)	16,750 (41)	16,500 (49.5)	16,000 (55.5)	16,000 (60)	16,000 (63.5)
55					13,650 (33.5)	14,300 (44.5)	14,100 (51)	14,100 (56.5)	14,100 (60)
60					11,150 (24)	12,000 (38.5)	12,200 (47)	12,200 (52.5)	12,200 (57)
65						10,100 (31.5)	10,800 (42)	10,600 (48.5)	10,600 (53.5)
70						8480 (22.5)	9410 (36.5)	9000 (44.5)	9000 (50)
75							8100 (30)	7800 (40)	7800 (46.5)
80							6920 (21.5)	6600 (34.5)	6600 (42.5)
85								5800 (28.5)	5800 (38)
90								5000 (20.5)	5000 (33)
95									4440 (27.5)
100									3880 (19.5)
Minimum boom angle (°) for indicated length (no load)									
									0
Maximum boom length (ft) at 0° boom angle (no load)									
									110

NOTE: ( ) Boom angles are in degrees.  
#LMI operating code. Refer to LMI manual for operating instructions.  
\*This capacity is based on maximum boom angle.

Lifting capacities at zero degree boom angle on outriggers fully extended - 360°

Boom angle	Main boom length in feet								
	36	40	50	**60	70	80	90	100	110
0°	29,050 (29.8)	24,450 (34.2)	17,050 (44.2)	11,950 (54.6)	9400 (64.2)	7310 (74.2)	6050 (84.2)	4660 (94.2)	3350 (104.2)

NOTE: ( ) Reference radii in feet.

\*\* Boom length is with inner-mid fully extended and outer-mid & fly fully retracted.

A6-829-101070

# Load chart RT760E

 36 ft - 110 ft    
  12,865 lb    
  100%    
  360°  
 23 ft 4 in spread

Feet	36	40	50	**60	70	80	90	100	110
10	120,000 (69)	84,400 (72)	80,200 (76)	*62,500 (78)					
12	100,000 (65.5)	84,400 (68.5)	80,200 (73.5)	62,500 (77)	*36,800 (78)				
15	85,400 (59.5)	82,700 (63.5)	80,200 (70)	61,000 (74)	36,800 (76.5)	*36,800 (78)	*31,000 (78)		
20	65,700 (49)	65,000 (55)	64,300 (63.5)	50,650 (69)	36,800 (72)	36,800 (75)	31,000 (77)	*29,100 (78)	*24,000 (78)
25	52,800 (36)	52,450 (45)	51,850 (56.5)	41,800 (63.5)	36,800 (68)	34,000 (71)	30,000 (73.5)	27,000 (76)	24,000 (77.5)
30		42,150 (31.5)	39,600 (48.5)	38,000 (57.5)	33,400 (63)	29,000 (67)	25,300 (70.5)	24,200 (72.5)	22,000 (75)
35			31,750 (40)	29,750 (51.5)	28,700 (58)	25,000 (63)	22,200 (67)	21,750 (69.5)	20,000 (72)
40			24,450 (28)	24,750 (45)	23,600 (53)	22,000 (59)	20,200 (63)	19,000 (66.5)	18,500 (69)
45				19,750 (37)	19,700 (47.5)	18,800 (54.5)	17,800 (59.5)	17,300 (63)	17,300 (66.5)
50				16,000 (26.5)	16,750 (41)	16,500 (49.5)	16,000 (55.5)	16,000 (60)	16,000 (63.5)
55					13,650 (33.5)	14,300 (44.5)	14,100 (51)	14,100 (56.5)	14,100 (60)
60					11,150 (24)	12,000 (38.5)	12,200 (47)	12,200 (52.5)	12,200 (57)
65						10,100 (31.5)	10,800 (42)	10,600 (48.5)	10,600 (53.5)
70						8480 (22.5)	9410 (36.5)	9000 (44.5)	9000 (50)
75							8100 (30)	7800 (40)	7800 (46.5)
80							6920 (21.5)	6600 (34.5)	6600 (42.5)
85								5800 (28.5)	5800 (38)
90								5000 (20.5)	5000 (33)
95									4440 (27.5)
100									3880 (19.5)
									0
									110

Minimum boom angle (°) for indicated length (no load)

Maximum boom length (ft) at 0° boom angle (no load)

NOTE: ( ) Boom angles are in degrees.

#LMI operating code. Refer to LMI manual for operating instructions.

\*This capacity is based on maximum boom angle.

Lifting capacities at zero degree boom angle  
on outriggers fully extended - 360°

Boom angle	36	40	50	**60	70	80	90	100	110
0°	29,050 (29.8)	24,450 (34.2)	17,050 (44.2)	11,950 (54.6)	9400 (64.2)	7310 (74.2)	6050 (84.2)	4660 (94.2)	3350 (104.2)

NOTE: ( ) Reference radii in feet.

\*\* Boom length is with inner-mid fully extended and outer-mid & fly fully retracted.

A6-829-101070

# Load chart RT700E



Pounds						
Feet	33 ft LENGTH			56 ft LENGTH		
	0°	25°	45°	0°	25°	45°
	OFFSET	OFFSET	OFFSET	OFFSET	OFFSET	OFFSET
	#0021	#0022	#0023	#0041	#0042	#0043
30	12,900 (78)					
35	12,900 (76)			*8330 (78)		
40	12,900 (74)	*10,850 (78)		8330 (77.5)		
45	12,900 (72)	10,450 (77)	*7410 (78)	8330 (76)		
50	12,100 (70)	10,000 (74.5)	7200 (77.5)	8330 (74.5)		
55	11,100 (68)	9220 (72.5)	6990 (75)	8250 (73)	*5300 (78)	
60	10,100 (66)	8550 (70.5)	6800 (72.5)	7540 (71)	5140 (77)	
65	9130 (63.5)	7930 (68)	6650 (70.5)	7160 (69)	5100 (75)	*3860 (78)
70	8460 (61.5)	7380 (65.5)	6490 (68)	6820 (67.5)	5100 (73)	3790 (77.5)
75	7840 (59)	6900 (63)	6370 (65.5)	6300 (65.5)	4800 (71)	3660 (75)
80	7230 (56.5)	6470 (60.5)	6110 (62.5)	5810 (63.5)	4580 (69)	3550 (73)
85	6690 (54)	6070 (58)	5780 (60)	5370 (61.5)	4470 (67.5)	3450 (71)
90	6140 (51)	5720 (55.5)	5480 (57)	4980 (59.5)	4330 (65.5)	3410 (68.5)
95	5670 (48.5)	5400 (52.5)	5200 (54)	4630 (57)	4070 (63)	3300 (66.5)
100	5020 (45.5)	5100 (49.5)	4950 (51)	4320 (55)	3830 (61)	3260 (64)
105	4350 (42.5)	4760 (46.5)	4650 (47.5)	4040 (52.5)	3620 (58.5)	3220 (62)
110	3750 (39.5)	4160 (43)		3770 (50.5)	3410 (56)	3180 (59.5)
115	3210 (36)	3600 (39.5)		3540 (48)	3230 (53.5)	3060 (56.5)
120	2720 (32)	3100 (35)		3300 (45.5)	3050 (51)	2940 (53.5)
125	2270 (27.5)	2640 (30.5)		2870 (42.5)	2890 (48.5)	2800 (50.5)
130	1860 (22)			2470 (39.5)	2730 (45.5)	
135				2110 (36.5)	2590 (42.5)	
140				1770 (33)	2250 (38.5)	
145				1460 (29.5)	1880 (34.5)	
150				1170 (25)		
Minimum boom angle (°) for indicated length	21	25	45	25	28	45
Maximum boom length (ft) at 0° boom angle (no load)	100			90		

NOTE: ( ) Boom angles are in degrees. A6-829-101289  
 #LMI operating code. Refer to LMI manual for operating instructions.  
 \*This capacity is based upon maximum boom angle.

### NOTES:

1. All capacities above the bold line are based on structural strength of boom extension and do not exceed 85% of tipping loads, in accordance with SAE J-765.

2. 33 ft and 56 ft boom extension lengths may be used for single line lifting service.

3. Radii listed are for a fully extended boom with the boom extension erected. For main boom lengths less than fully extended, the rated loads are determined by boom angle. Use only the column which corresponds to the boom extension length and offset for which the machine is configured. For boom angles not shown, use the rating of the next lower boom angle.

**WARNING:** Operation of this machine with heavier loads than the capacities listed is strictly prohibited. Machine tipping with boom extension occurs rapidly and without advance warning.

4. Boom angle is the angle above or below horizontal of the longitudinal axis of the boom base section after lifting rated load.

5. Capacities listed are with outriggers fully extended and vertical jacks set only.



# Load chart RT700E









Pounds						
Feet	33 ft LENGTH			56 ft LENGTH		
	0°	25°	45°	0°	25°	45°
	OFFSET #0064	OFFSET #0065	OFFSET #0066	OFFSET #0084	OFFSET #0085	OFFSET #0086
35	<sup>*</sup> 9360 (78)					
40	9360 (77)			<sup>*</sup> 6300 (78)		
45	8480 (75.5)	<sup>*</sup> 7480 (78)		6300 (77.5)		
50	7680 (73.5)	7070 (77.5)	<sup>*</sup> 5880 (78)	6000 (76.5)		
55	6990 (71.5)	6470 (76)	5880 (77.5)	5990 (75)		
60	6390 (70)	5970 (74)	5480 (76.5)	5980 (73.5)	<sup>*</sup> 4840 (78)	
65	5890 (68)	5570 (72)	5080 (74.5)	5510 (72)	4840 (77.5)	
70	5390 (66)	5070 (70)	4780 (72.5)	5010 (70)	4440 (76.5)	
75	4990 (64)	4770 (68)	4480 (70.5)	4560 (68.5)	4050 (74.5)	<sup>*</sup> 3760 (78)
80	4650 (62)	4400 (66)	4190 (68.5)	4170 (67)	3870 (73)	3460 (76.5)
85	4300 (60)	4150 (64)	3890 (66)	3820 (65)	3570 (71)	3260 (74.5)
90	4000 (58)	3850 (62)	3690 (64)	3520 (63.5)	3320 (69.5)	2960 (73)
95	3760 (55.5)	3650 (59.5)	3500 (61.5)	3220 (61.5)	3070 (67.5)	2770 (71)
100	3510 (53.5)	3410 (57.5)	3300 (59.5)	2980 (60)	2880 (66)	2570 (69)
105	3260 (51)	3210 (55)	3100 (57)	2780 (58)	2680 (64)	2460 (67)
110	3070 (48.5)	3020 (52.5)	2930 (54.5)	2530 (56)	2480 (62)	2340 (65)
115	2870 (46)	2870 (50)	2780 (51.5)	2340 (54)	2280 (60)	2200 (63)
120	2730 (43.5)	2730 (47)		2190 (52)	2140 (58)	2050 (60.5)
125	2530 (40.5)	2580 (44)		2000 (50)	1990 (55.5)	1910 (58.5)
130	2210 (37.5)	2440 (41)		1850 (48)	1850 (53.5)	1810 (56)
135	1850 (34.5)	2150 (37.5)		1720 (45.5)	1750 (51)	1670 (53.5)
140	1510 (30.5)	1750 (34)		1610 (43)	1610 (48.5)	
145	1200 (26.5)				1520 (46)	
150					1370 (43)	
Minimum boom angle (°) for indicated length (no load)	20	25	45	40	41	45
Maximum boom length (ft) at 0° boom angle (no load)		90		70		

NOTE: ( ) Boom angles are in degrees.  
 #LMI operating code. Refer to LMI manual for operating instructions.  
<sup>\*</sup>This capacity is based upon maximum boom angle.

## NOTES:

1. All capacities above the bold line are based on structural strength of boom extension and do not exceed 85% of tipping loads, in accordance with SAE J-765.
2. 33 ft and 56 ft boom extension lengths may be used for single line lifting service only.
3. For main boom lengths less than 110 ft with the boom extension erected, the rated loads are determined by boom angle. Use only the column which corresponds to the boom extension length and offset for which the machine is set up. For boom angles not shown, use rating of the next lower boom angle.
- WARNING:** Operation of this machine with heavier loads than the capacities listed is strictly prohibited. Machine tipping with boom extension occurs rapidly and without advance warning.
4. Boom angle is the angle above or below horizontal of the longitudinal axis of the boom base section after lifting rated load.
6. Capacities listed are with outriggers fully extended and vertical jacks set only.

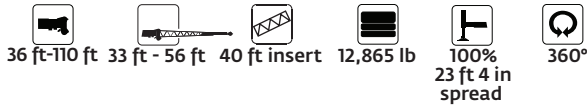
# Load chart



Pounds						
Feet	33 ft LENGTH			56 ft LENGTH		
	0° OFFSET #0064	25° OFFSET #0065	45° OFFSET #0066	0° OFFSET #0084	25° OFFSET #0085	45° OFFSET #0086
45	6560 (78)					
50	5960 (76)			4510 (78)		
55	5360 (74.5)	5860 (78)		4210 (77.5)		
60	4860 (73)	5260 (76.5)	*5170 (78)	3910 (76)		
65	4370 (71)	4870 (75)	4670 (77.5)	3710 (74.5)		
70	3970 (69.5)	4370 (73)	4270 (75.5)	3410 (73)	*3710 (78)	
75	3670 (67.5)	4070 (71.5)	3980 (73.5)	3220 (71.5)	3420 (77.5)	
80	3270 (66)	3670 (69.5)	3680 (72)	2820 (70)	3120 (76)	
85	2980 (64)	3370 (68)	3380 (70)	2520 (68.5)	2820 (74.5)	2730 (77.5)
90	2780 (62.5)	3080 (66)	3080 (68)	2320 (66.5)	2620 (72.5)	2530 (76)
95	2480 (60.5)	2880 (64)	2890 (66)	2030 (65)	2330 (71)	2340 (74.5)
100	2290 (58.5)	2580 (62)	2690 (64)	1830 (63.5)	2130 (69.5)	2140 (72.5)
105	2090 (56.5)	2390 (60)	2390 (62)	1630 (62)	1930 (68)	1940 (71)
110	1900 (54.5)	2190 (58)	2200 (60)	1440 (60)	1730 (66)	1740 (69)
115	1700 (52.5)	2000 (56)	2100 (58)	1240 (58.5)	1540 (64.5)	1550 (67)
120	1600 (50.5)	1800 (54)	1910 (55.5)	1140 (57)	1340 (62.5)	1450 (65)
125	1410 (48)	1700 (51.5)	1710 (53)		1240 (61)	1260 (63.5)
130	1310 (46)	1510 (49.5)	1520 (50.5)		1050 (59)	1160 (61.5)
135	1120 (43.5)	1420 (47)	1420 (48)			
140	1030 (41)	1220 (44.5)				
145		1130 (41.5)				
150		1040 (38.5)				
No load stability data						
Min. boom angle at 110 ft boom length	37°	37°	45°	54°	56°	58°
Max. boom length at 0° boom angle		70 ft			40 ft	

NOTE: ( ) Boom angles are in degrees. A6-829-101581  
 \*This capacity is based upon maximum boom angle.  
 #LMI operating code. Refer to LMI manual for instructions.

## NOTES:

- All capacities above the bold line are based on structural strength of boom extension and do not exceed 85% of tipping loads, in accordance with SAE J-765.
  - 33 ft and 56 ft boom extension lengths may be used for single line lifting service only.
  - For main boom lengths less than 110 ft with the boom extension erected, the rated loads are determined by boom angle. Use only the column which corresponds to the boom extension length and offset for which the machine is set up. For boom angles not shown, use rating of the next lower boom angle.
- WARNING:** Operation of this machine with heavier loads than the capacities listed is strictly prohibited. Machine tipping with boom extension occurs rapidly and without advance warning.
- Boom angle is the angle above or below horizontal of the longitudinal axis of the boom base section after lifting rated load.
  - Capacities listed are with outriggers fully extended and vertical jacks set only.

# Load charts RT700E









Pounds					
#9005					
Feet	Main boom length in feet				
	36	40	50	°60	70
10	45,300 (69)	39,700 (72)			
12	41,750 (65.5)	39,700 (68.5)	29,600 (73.5)		
15	29,350 (59.5)	26,450 (63.5)	26,450 (70)	20,900 (74)	
20	17,800 (49)	17,650 (55)	17,050 (63.5)	16,250 (69)	16,250 (72)
25	11,750 (36)	11,700 (45)	11,350 (56.5)	10,850 (63.5)	10,850 (68)
30		8040 (31.5)	7820 (48.5)	7470 (57.5)	7470 (63)
35			5400 (40)	5120 (51.5)	5120 (58)
40			3660 (28)	3200 (45)	3430 (53)
45				1000 (37)	2150 (47.5)
50					1150 (41.0)

Lifting capacities at zero degree boom angle on rubber - stationary 360°

Boom angle	Main boom length in feet		
	36	40	50
0°	8180 (29.7)	5890 (34.2)	2170 (44.2)

Note: ( ) Reference radii in feet. A6-829-101048A  
 #LMI operating code. Refer to LMI manual for instructions.  
 \*60 ft boom length is with inner-mid extended and outer-mid & fly retracted.









Pounds					
#9005					
Feet	Main boom length in feet				
	36	40	50	°60	70
10	45,300 (69)	42,850 (72)	29,600 (76)		
12	43,650 (65.5)	41,350 (68.5)	29,600 (73.5)		
15	38,300 (59.5)	36,300 (63.5)	29,600 (70)	20,900 (74)	17,300 (76.5)
20	31,150 (49)	29,550 (55)	25,900 (63.5)	20,900 (69)	17,300 (72)
25	24,100 (36)	24,150 (45)	21,800 (56.5)	18,800 (63.5)	17,300 (68)
30		17,400 (31.5)	17,200 (48.5)	15,300 (57.5)	15,300 (63)
35			12,800 (40)	12,500 (51.5)	11,000 (58)
40			9720 (28)	9390 (45)	9390 (53)
45				7090 (37)	7090 (47.5)
50				5310 (26.5)	5310 (41)
55					3870 (33.5)
60					3170 (24)

Lifting capacities at zero degree boom angle on rubber - defined arc over front

Boom angle	Main boom length in feet				
	36	40	50	°60	70
0°	17,600 (29.7)	13,600 (34.2)	7750 (44.2)	4010 (54.6)	2670 (64.2)

Note: ( ) Reference radii in feet. A6-829-101047  
 #LMI operating code. Refer to LMI manual for instructions.  
 \*60 ft boom length is with inner-mid extended and outer-mid & fly retracted.

Pounds					
#9006					
Feet	Main boom length in feet				
	36	40	50	°60	70
10	42,500 (69)	37,600 (72)	30,700 (76)		
12	42,500 (65.5)	37,600 (68.5)	30,700 (73.5)	23,450 (77)	
15	37,600 (59.5)	37,600 (63.5)	30,700 (70)	19,700 (74)	16,250 (76.5)
20	32,950 (49)	32,900 (55)	30,700 (63.5)	19,700 (69)	16,250 (72)
25	24,100 (36)	24,150 (45)	23,850 (56.5)	19,700 (63.5)	16,250 (68)
30		17,400 (31.5)	17,200 (48.5)	16,800 (57.5)	16,250 (63)
35			12,800 (40)	12,500 (51.5)	12,500 (58)
40			9,720 (28)	9,390 (45)	9,390 (53)
45				7,090 (37)	7,090 (47.5)
50				5,310 (26.5)	5,310 (41)
55					3,870 (33.5)
60					3,090 (24)

Lifting capacities at zero degree boom angle on rubber - pick and carry

Boom angle	Main boom length in feet				
	36	40	50	°60	70
0°	17,600 (29.7)	13,600 (34.2)	7750 (44.2)	4010 (54.6)	2670 (64.2)

Note: ( ) Reference radii in feet. A6-829-101049  
 #LMI operating code. Refer to LMI manual for instructions.  
 \*60 ft boom length is with inner-mid extended and outer-mid & fly retracted.

## NOTES TO ALL RUBBER CAPACITY CHARTS:

- Capacities are in pounds and do not exceed 75% of tipping loads as determined by test in accordance with SAE J765.
- Capacities are applicable to machines equipped with 29.5 x 25 (28 ply) tires at 65 psi cold inflation pressure.
- Defined Arc - Over front includes 6° on either side of longitudinal centerline of machine (ref. drawing C6-829-003529).
- Capacities appearing above the bold line are based on structural strength and tipping should not be relied upon as a capacity limitation.
- Capacities are applicable only with machine on firm level surface.
- On rubber lifting with boom extensions not permitted.
- For pick and carry operation, boom must be centered over front of machine, mechanical swing lock engaged and load restrained from swinging. When handling loads in the structural range with capacities close to maximum ratings, travel should be reduced to creep speeds.
- Axle lockouts must be functioning when lifting on rubber.
- All lifting depends on proper tire inflation, capacity and condition. Capacities must be reduced for lower tire inflation pressures. See lifting capacity chart for tire used. Damaged tires are hazardous to safe operation of crane.
- Creep - not over 200 ft of movement in any 30 minute period and not exceeding 1 mph.

THIS CHART IS ONLY A GUIDE AND SHOULD NOT BE USED TO OPERATE THE CRANE.

# Load chart

## Weight reductions for load handling devices

### 33 ft - 56 ft Folding boom extension

\*33 ft extension (erected) - 5080 lb  
 \*56 ft extension (erected) - 11,330 lb

### Folding extension with 20 ft insert

\*33 ft extension (erected) - 11,248 lb  
 \*56 ft extension (erected) - 19,372 lb

### Folding extension with 40 ft insert

\*33 ft extension (erected) - 19,671 lb  
 \*56 ft extension (erected) - 29,671 lb

\*Reduction of main boom capacities  
 (no deduct required for stowed boom extension)

When lifting over swingaway and/or jib combinations, deduct total weight of all load handling devices reeved over main boom nose directly from swingaway or jib capacity.

**NOTE:** All load handling devices and boom attachments are considered part of the load and suitable allowances **MUST BE MADE** for their combined weights. Weights are for Grove furnished equipment.

## Line pulls and reeving information

Hoists	Cable specs	Permissible line pulls	Nominal cable length
Main	19 mm (3/4 in) 6 x 37 class, EIPS, IWRC Special Flexible Min. Breaking Str. 58,800 lb	16,800 lb	500 ft
Main and auxiliary	19 mm (3/4 in) Flex-X 35 Rotation resistant (non-rotating) Min. breaking Str. 85,800 lb	16,800 lb	500 ft

The approximate weight of 3/4 in wire rope is 1.5 lb/ft.

## 60 Ust reeving diagram

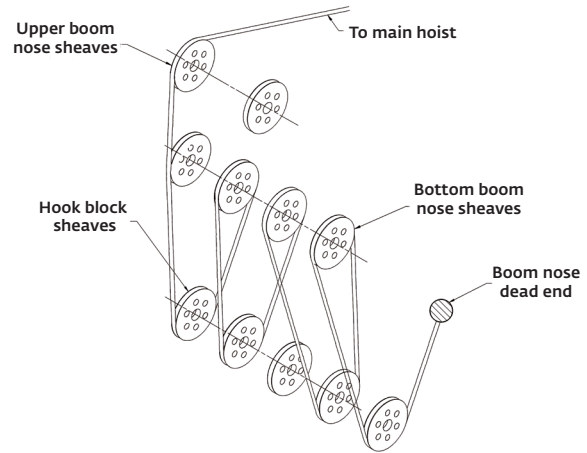

## Line pulls and reeving information

Auxiliary boom nose	137 lb
<b>Hookblocks and headache balls:</b>	
60 Ust, 5 Sheave	1250 lb +
50 Ust, 4 Sheave	1000 lb +
50 Ust, 3 Sheave	1000 lb +
8.3 Ust headache ball (non-swivel)	350 lb +
8.3 Ust headache ball (swivel)	370 lb +

+Refer to rating plate for actual weight.

## Hoist performance

Wire rope layer	Hoist line pulls two-speed hoist		Drum rope capacity (ft)			
	Low available lb <sup>2</sup>	High available lb <sup>2</sup>	Layer 16 in drum	Total 16 in drum	Layer 26 in drum	Total 26 in drum
1	18,134	9067	78	78	132	132
2	16,668	8334	85	164	144	276
3	15,420	7710	92	256	156	432
4	14,347	7174	99	356	167	599
5	13,413	6707	106	462	179	778
6	12,594	6297	113	575	190	968

\* Max lifting capacity: 6 x 37 class or 35 x 7 class = 16,800 lb

## Working area diagram

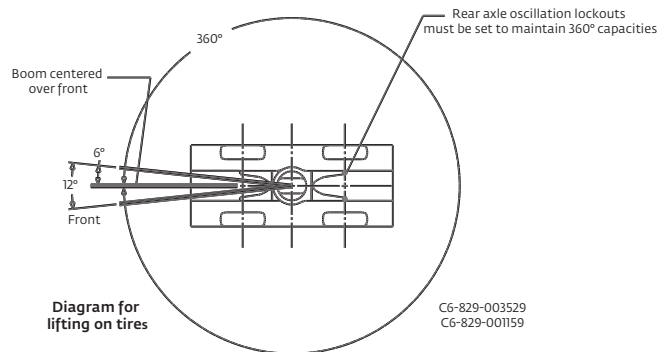
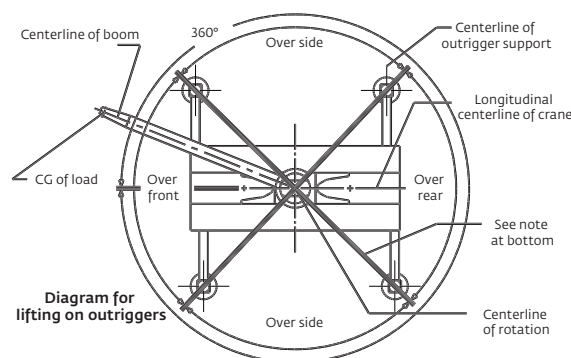

C6-829-003529  
 C6-829-001159









Bold lines determine the limiting position of any load for operation within working areas indicated.

*THIS CHART IS ONLY A GUIDE AND SHOULD NOT BE USED TO OPERATE THE CRANE.*

*The individual crane's load chart, operating instructions and other instructional plates must be read and understood prior to operating the crane.*



# Symbols glossary

 Axles	 Counterweight	 Grade	 Outriggers
 Boom	 Drive	 Height (no max)	 Radius
 Boom elevation	 Electrical system	 Heavy duty jib	 Rotation
 Boom extension	 Engine	 Hoist	 Speed
 Boom length	 Extension	 Hookblock	 Steering
 Boom nose	 Frame	 Hydraulic system	 Suspension
 Brakes	 Fuel tank capacity	 Lights	 Swing
 Cab	 Gear	 Oil	 Tires
		 Outrigger controls	 Transmission

# Notes



## Regional headquarters

### Manitowoc - Americas

**Manitowoc, Wisconsin, USA**

Tel: +1 920 684 6621

Fax: +1 920 683 6277

**Shady Grove, Pennsylvania, USA**

Tel: +1 717 597 8121

Fax: +1 717 597 4062

### Manitowoc - Europe, Middle East, Africa

**Ecully, France**

Tel: +33 (0)4 72 18 20 20

Fax: +33 (0)4 72 18 20 00

### Manitowoc - Asia Pacific

**Shanghai, China**

Tel: +86 21 6457 0066

Fax: +86 21 6457 4955

## Regional offices

### Americas

#### Brazil

Alphaville

#### Mexico

Monterrey

#### Chile

Santiago

### Europe, Middle East, Africa

#### Czech Republic

Netvorice

#### France

Baudemont

Cergy

Decines

#### Germany

Langenfeld

#### Hungary

Budapest

#### Italy

Lainate

#### Netherlands

Breda

#### Poland

Warsaw

### Portugal

Baltar

### Russia

Moscow

### U.A.E.

Dubai

### U.K.

Buckingham

### Asia - Pacific

#### Australia

Brisbane

Melbourne

Sydney

#### China

Beijing

Chengdu

Guangzhou

#### India

Delhi

Hyderabad

Pune

#### Korea

Seoul

#### Philippines

Makati City

Singapore

## Factories

### Brazil

Alphaville

### China

TaiAn

Zhangjiagang

### France

Charlieu

La Clayette

Moulins

### Germany

Wilhelmshaven

### India

Pune

### Italy

Niella Tanaro

### Portugal

Baltar

Fânzeres

### Slovakia

Saris

### USA

Manitowoc

Port Washington

Shady Grove

This document is non-contractual. Constant improvement and engineering progress make it necessary that we reserve the right to make specification, equipment, and price changes without notice. Illustrations shown may include optional equipment and accessories and may not include all standard equipment.