

Grove TMS700E

Product Guide



Features

- 50 t or 55 t (50 USt or 60 USt) capacity
- 11 m – 33,5 m (36 ft – 110 ft) four-section, full power sequenced synchronized boom
- 10,1 m – 17 m (33 ft – 56 ft) offsettable bi-fold lattice swingaway extension
- Optional 6,1 m (20 ft) or 12,2 m (40 ft) swingaway extension inserts
- Grove MEGAFORM™ boom
- Up to 7484 kg (16,500 lb) hydraulically installed and removed counterweight



Features

Swingaway extension inserts

Optional 6,1 m (20 ft) or 12,2 m (40 ft) swingaway extension inserts offer excellent capacities with an unprecedented tip height of up to 212 ft.

CraneSTAR

CraneSTAR is an exclusive and innovative crane asset management system that helps improve your profitability and reduce costs by remotely monitoring critical crane data. Visit www.cranestar.com for more information.

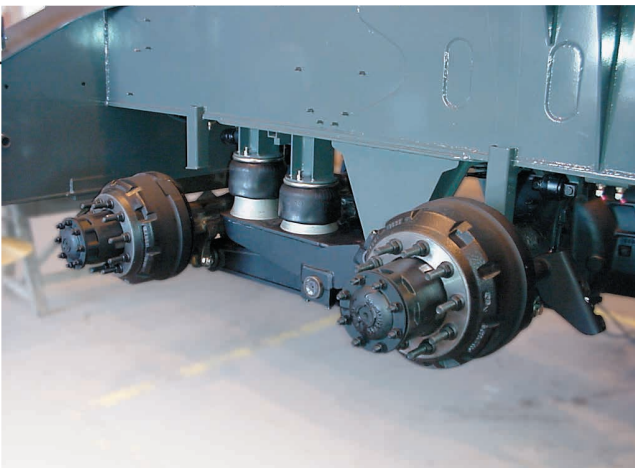

Suspension system

Standard front and rear air ride suspension provides a comfortable ride at maximum speed of 105 km/h (65 mph).

Cummins diesel carrier engine

Cummins ISX 12 diesel carrier engine delivers the horsepower and torque needed to negotiate tough job sites and achieve highway travel speeds.

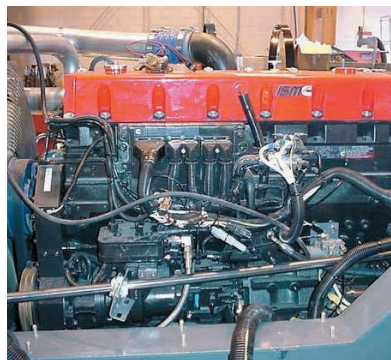

MEGAFORM™ boom

The 11 m – 33,5 m (36 ft – 110 ft) four-section full power sequenced synchronized MEGAFORM™ boom is designed for maximum vertical and lateral strength.



Contents

Specifications	4
Dimensions	7
Travel proposals	8
Working range	9
Main boom and swingaway charts	10
Working range with inserts	18
Swingaway charts with inserts	19
Load handling	21
Metric 85% working range	22
Metric 85% load charts	23
Symbols glossary	38

Specifications

Superstructure



Boom

11 m – 33,5 m (36 ft – 110 ft) four (4) section, full power sequenced synchronized boom.

Maximum tip height: 35,9 m (118 ft).



Folding lattice extension

10,1 m – 17,1 m (33 ft – 56 ft) folding lattice swingaway extension offsettable at 0°, 25° or 45°. Stows alongside base boom section.

Maximum tip height: 52,6 m (172.5 ft).



*Lattice extension

Two (2) 6,1 m (20 ft) lattice extensions used with the swingaway extension to increase the length to 23,2 m (76 ft) or 29,3 m (96 ft).

Maximum tip height: 64,6 m (212 ft).



Boom nose

Quick reeving type boom nose with 3 nylatron sheaves (TMS750E), (4 for TMS760E [55 t (60 USt) rating]) mounted on heavy duty tapered roller bearings with removable pin-type rope guards. Removable auxiliary boom nose with removable pin type rope guard.



Boom elevation

One double acting hydraulic cylinder with integral holding valve provides elevation from -3° to 78°.



Load moment and anti-two block system

Standard “Graphics Display” load moment and anti-two block system with audio-visual warning and control lever lockout. These systems provide electronic display of boom angle, boom length, radius, tip height, relative load moment, maximum permissible load, load indication and warning of impending two-block condition. The standard “Work Area Definition System” allows the operator to pre-select and define safe working areas. If the crane approaches the pre-set limits, audio-visual warnings aid the operator in avoiding job-site obstructions.



Cab

High visibility, all steel cab with acoustical lining and tinted safety glass throughout. Deluxe seat with armrest mounted hydraulic single axis controls. Dash panel incorporates gauges for all engine functions. Other standard features include: sliding side and rear windows, hot water heat, electric windshield wash/wipe, circulating air fan, sliding skylight with sunscreen and electric skylight wiper, fire extinguisher, cup holder, air conditioning.



Swing

Planetary swing with foot applied multi-disc wet brake. Spring applied, hydraulically released parking brake. Two position plunger type and 360° mechanical house locks operated from cab.

Maximum speed: 2.0 rpm.

Counterweight

4990 kg (11,000 lb) consisting of (2) 2495 kg ([2] 5500 lb) sections. *Optional “Heavy Lift” package consisting of (1) additional 2495 kg (5500 lb) section, for a total of 7484 kg (16,500 lb). Hydraulic installation/removal.



Hydraulic system

Four main gear pumps with a combined capacity of 513 L/m (135.4 gpm). Individual pressure compensated valve banks. Maximum operating pressure: 27,6 Mpa (4000 psi).

Return line type filter with full flow by-pass protection and service indicator. Replaceable cartridge with beta rating of 5/12/16. 643 L (170 gal) reservoir. Remote mounted oil cooler with thermostatically controlled electric motor driven fan.

Specifications

Superstructure continued



Hoist main and auxiliary hoists-model HP30A-19G

Planetary reduction with integral automatic brake, electronic hoist drum rotation indicator, and hoist drum cable follower. Grooved drum.

Single line pull: 1st layer: 8226 kg (18,134 lb)
3rd layer: 6994 kg (15,420 lb)
5th layer: 6084 kg (13,413 lb)

Maximum single line speed: 162 m/min
(531 fpm)

Maximum permissible line pull: 7620 kg (16,800 lb)
with standard 6 x 37
class rope

7620 kg (16,800 lb)
with optional 35 x 7
class rope

Rope diameter: 19 mm (.75 in)

Rope length: 152 m (500 ft)

Maximum rope stowage: 256 m (841 ft)

Carrier



Chassis

Triple box section, four-axle carrier, fabricated from high strength, low alloy steel with towing and tie-down lugs.



Outrigger system

Four hydraulic telescoping, single stage, double box beam outriggers with inverted jack and integral holding valves. Quick release type steel outrigger floats 610 mm (24 in) diameter. Three position setting with fully extended, intermediate (50%) extended and fully retracted capacities. 5th front jack with self-storing pad and automatic first-retract. Includes Outrigger Monitoring System.

Maximum outrigger pad load: 90,890 lb



Outrigger controls

Located in the superstructure cab and both sides of chassis. Level indicator at each control station.



Engine- North America

Cummins ISX 12 six-cylinder, turbo-charged and after-cooled diesel engine. 12 L (732 in³) 336 kW (450 bhp) at 1800 rpm. Maximum torque 2102 Nm (1550 lb-ft) at 1400 rpm. 2013 "On Highway" EPA, CARB compliant.

Equipped with engine compression brake, audio-visual engine distress system and ether cold start aid.

Fuel Requirement: Maximum of 15 ppm sulfur content (Ultra Low Sulfur Diesel). Diesel exhaust fluid required.



Engine- Export

Cummins QSM 11 six-cylinder, turbo-charged and after-cooled diesel engine. 10.8 L (660 in³), 300 kW (402 bhp) at 1800 rpm. Maximum torque 1898 Nm (1400 lb-ft) at 1400 rpm. Tier III "Off-Highway" EPA, CARB and EU Stage IIIA compliant.

Equipped with engine compression brake, audio-visual engine distress system and ether cold start aid.

Fuel Requirement: Maximum of 5000 ppm sulfur content.



Fuel tank capacity

379 L (100 gal).



Transmission

Roadranger 11 speeds forward, 3 reverse, manual.



Drive

Drive 8 x 4 x 4.



Steering

Front axles, single circuit, mechanical steering with hydraulic assist.



Axles

Front: (2) beam-type steering axles, 2,1 m (83.3 in) track.

Rear: (2) single reduction drive axles, 1,9 m (75.1 in) track. Inter-axle differential lock.

Specifications

Carrier continued

Brakes

S-cam, dual system operating on all wheels. Spring applied air released parking brake acting on rear axles. Air dryer.

Suspension

Front: Walking beam with air bags and shock absorbers.

Rear: Walking beam with air bags and shock absorbers.

Tires

Front: 445/65R 22.5, tubeless, mounted on aluminum disc wheels.

Rear: 315/80R 22.5, tubeless, mounted on aluminum disc wheels, steel inner.

Lights

Full lighting package including turn indicators, head, tail, brake, and hazard warning lights.

Cab

One man design, all steel fabricated with acoustical lining and tinted safety glass throughout. Deluxe fabric covered, fully adjustable air ride seat. Complete driving controls and engine instrumentation including tilt telescope steering wheel, tachometer, speedometer, voltmeter, water temp., oil pressure, fuel level, air pressure gauge with A/V warning and engine high temp./low oil pressure A/V warning. Other standard items include hot water heater/defroster, electric windshield wash/wipe, fire extinguisher, seat belt, air conditioning, air horn and door lock.

Electrical system

Three (3) 12V batteries. 12V lighting/starting. Battery disconnect standard equipment.

Maximum speed

104 km/h (65 mph)

Gradeability (theoretical)

70%

Miscellaneous standard equipment

Aluminum fenders with rear storage compartments; dual rear view mirrors; electronic back-up alarm; pump disconnect; tire inflation kit; air cleaner restriction indicator; headache ball stowage; chrome package which includes aluminum wheels, hoist access platform, LMI event recorder and CraneSTAR asset management system.

*Optional equipment

- ▶ **Auxiliary Lighting and Convenience Package** — includes amber strobe for superstructure and carrier cabs, dual boom base mounted floodlights, and LMI light bar (in cab)
- ▶ **Trailing Boom Package** — includes trailer air and electrical disconnects, no spin differential and trailing boom kit (less dolly)
- ▶ Wind speed indicator
- ▶ Hook blocks
- ▶ Rear pintle hook
- ▶ Cross axle differential locks
- ▶ Winter front radiator cover
- ▶ Aluminum outrigger pads
- ▶ Tow cable
- ▶ LMI calibration for on rubber

Dimensions

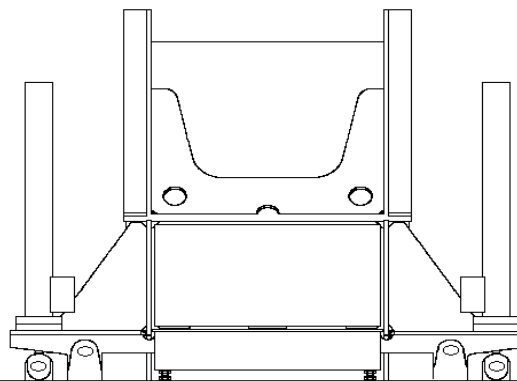
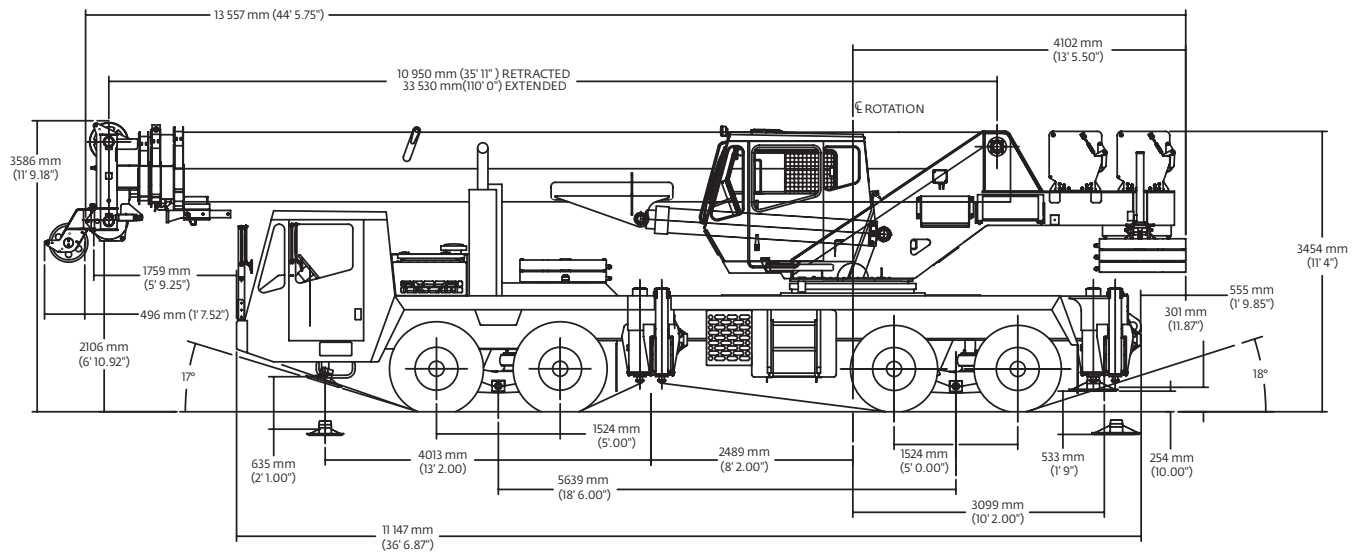
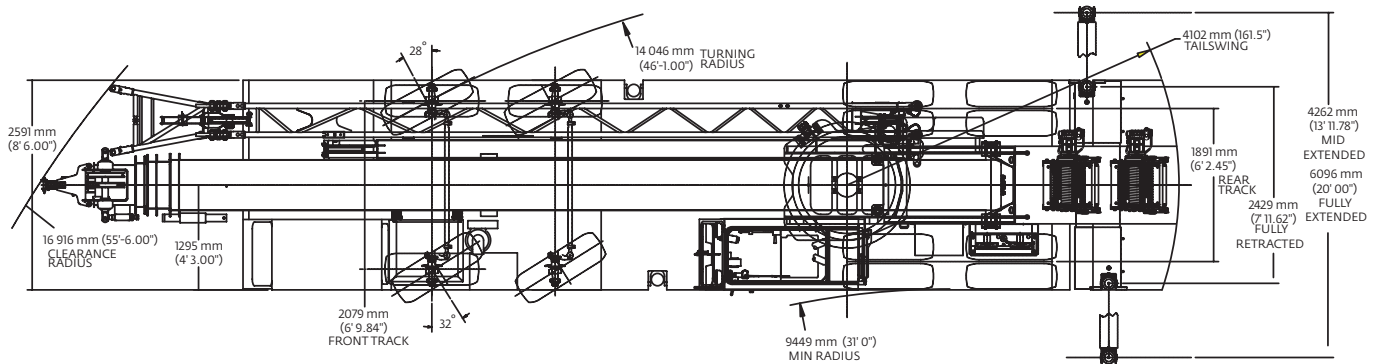

1.	2495 kg (5500 lb)			
2.	2495 kg (5500 lb)			
3.	2495 kg (5500 lb)			

1 2 3

Counterweight configuration

Zero

2495 kg (5500 lb) ●

4990 kg (11,000 lb) ● ●

7485 kg (16,500 lb) ● ● ●

Travel proposals

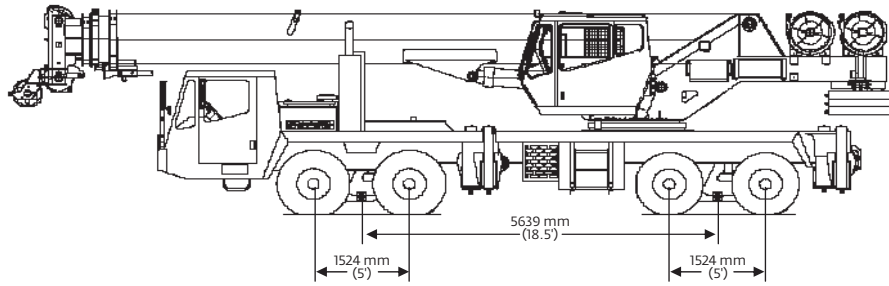

Boom over front unit configuration kg (lb)	Gross		Front		Rear	
Basic machine including 33.5 m (110 ft) main boom, ISX12 on-highway engine, main and auxiliary hoists with cable, driver and no counterweight.	34 463	(75,978)	17 203	(37,926)	17 260	(38,052)
Additions:						
2495 kg (5500 lb) counterweight pinned on superstructure	2495	(5500)	-1004	(-2214)	3499	(7714)
4990 kg (11,000 lb) counterweight pinned on superstructure	4990	(11,000)	-2009	(-4428)	6998	(15,428)
7485 kg (16,500 lb) counterweight pinned on superstructure	7484	(16,500)	-3013	(-6642)	10 497	(23,142)
2495 kg (5,500 lb) counterweight stowed on carrier deck	2495	(5500)	2128	(4692)	367	(808)
4990 kg (11,000 lb) counterweight stowed on carrier deck	4990	(11,000)	4257	(9384)	733	(1616)
Swingaway carrier brackets	133	(293)	110	(243)	23	(50)
10,1 m - 17,1 m (33 ft - 56 ft) swingaway	1132	(2495)	1,147	(2528)	-15	(-33)
Auxiliary boom nose	59	(130)	115	(253)	-56	(-123)
36 t (40 USt) - tied to the bumper	373	(823)	632	(1394)	-259	(-571)
45 t (50 USt) - tied to the bumper	458	(1010)	776	(1711)	-318	(-701)
55 t (60 USt) - tied to the bumper	581	(1280)	983	(2168)	-403	(-888)
7,5 t (8.3 USt) headache ball stowed	161	(355)	237	(523)	-76	(-168)
7,5 t (8.3 USt) headache ball tied to the bumper	161	(355)	269	(593)	-108	(-238)
Air conditioning superstructure cab	90	(198)	3	(7)	87	(191)
Air conditioning chassis cab	24	(53)	29	(65)	-5	(-12)
Substitutions:						
Aluminum outrigger floats	-33	(-72)	4	(8)	-36	(-80)
QSM off-highway engine	-427	(-941)	-464	(-1022)	37	(81)

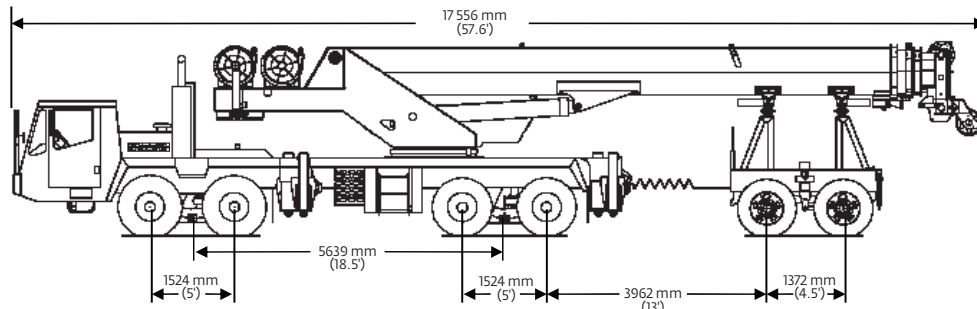

Trailing boom unit configuration kg (lb)	Gross		Front		Rear		Dolly	
Basic machine including 33.5 m (110 ft) main boom, ISX12 on-highway engine, main and auxiliary hoists with cable, driver, no counterweight and 2722 kg (6000 lb) tandem axle dolly.	37,215	(82,045)	15,602	(34,397)	13,356	(29,445)	8258	(18,206)
Additions:								
2495 kg (5500 lb) counterweight stowed on carrier deck	2495	(5500)	2128	(4692)	367	(808)	0	0
4990 kg (11,000 lb) counterweight stowed on carrier deck.	4990	(11,000)	4257	(9384)	733	(1616)	0	0
10,1 m - 17,1 m (33 ft - 56 ft) swingaway with brackets.	1265	(2788)	191	(421)	162	(357)	912	(2010)
Auxiliary boom nose	59	(130)	-11	(-25)	-10	(-21)	80	(176)
Air conditioning superstructure cab	90	(198)	37	(82)	53	(116)	0	0
Air conditioning chassis cab	24	(53)	29	(65)	-5	(-12)	0	0
35 t (40 USt) hookblock hanging at boom nose.	373	(823)	-59	(-130)	-50	(-110)	482	(1063)
45 t (50 USt) hookblock hanging at boom nose.	458	(1010)	-72	(-159)	-61	(-135)	592	(1304)
55 t (60 USt) hookblock hanging at boom nose.	581	(1280)	-91	(-201)	-78	(-171)	750	(1653)
7,5 t (8.3 USt) headache ball hanging at boom nose.	161	(355)	-25	(-56)	-21	(-47)	208	(458)
7,5 t (8.3 USt) headache ball stowed	161	(355)	237	(523)	-76	(-168)	0	0
Substitutions:								
Aluminum outrigger floats	-33	(-72)	4	(8)	-36	(-80)	0	0
QSM off-highway engine	-427	(-941)	-464	(-1022)	37	(81)	0	0

Working range

36 ft – 110 ft main boom and 33 ft – 56 ft lattice extension

(BOOM DEFLECTION NOT SHOWN)

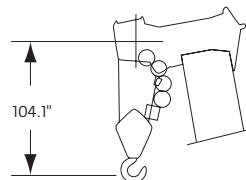
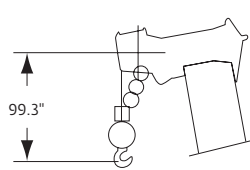
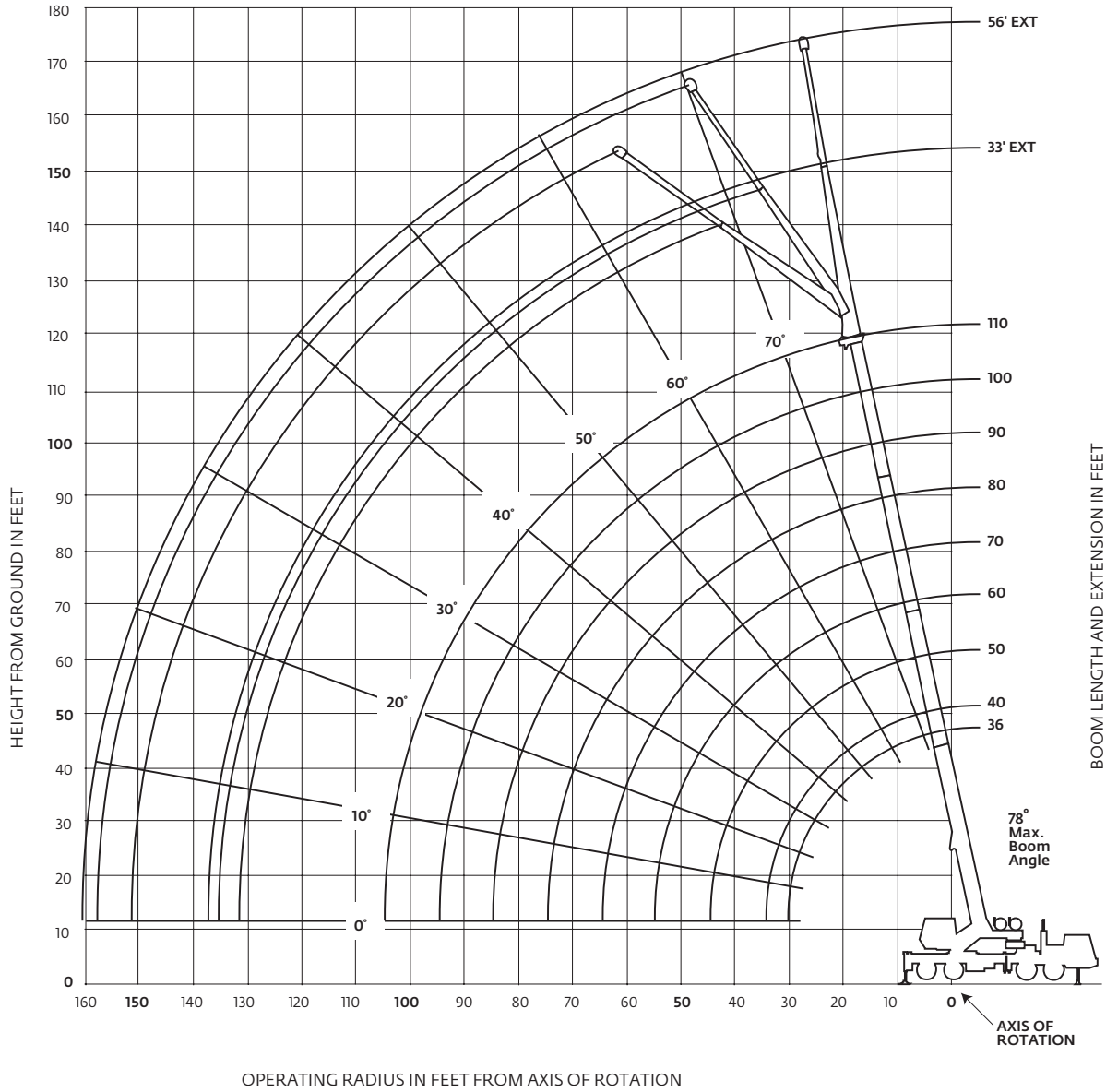

Dimensions are for largest Grove furnished hook block and headache ball, with anti-two block activated.

THIS CHART IS ONLY A GUIDE AND SHOULD NOT BE USED TO OPERATE THE CRANE.

The individual crane's load chart, operating instructions and other instructional plates must be read and understood prior to operating the crane.

TMS760E load charts



36 ft – 110 ft



16,500 lb



100%
20 ft



360°



#0001

Feet	Main boom length in feet									
	35	40	50	**60	70	80	90	100	110	
10	120,000 (69)	84,400 (72)	80,200 (76)	*62,500 (78)						
12	100,000 (65.5)	84,400 (68.5)	80,200 (73.5)	62,500 (77)	*36,800 (78)					
15	87,300 (59.5)	82,700 (63.5)	80,200 (70)	61,000 (74)	36,800 (76.5)	*36,800 (78)	*31,000 (78)			
20	68,250 (49)	65,000 (55)	64,300 (63.5)	50,650 (69)	36,800 (72)	36,800 (75)	31,000 (77)	*29,100 (78)	*24,000 (78)	
25	54,900 (36)	53,100 (45)	52,000 (56.5)	41,800 (63.5)	36,800 (68)	34,000 (71)	30,000 (73.5)	27,000 (76)	24,000 (77.5)	24,000 (78)
30		39,350 (31.5)	38,700 (48.5)	37,850 (57.5)	33,400 (63)	29,000 (67)	25,300 (70.5)	24,200 (72.5)	22,000 (75)	22,000 (75)
35			29,400 (40)	28,400 (51.5)	28,700 (58)	25,000 (63)	22,200 (67)	21,750 (69.5)	20,000 (72)	20,000 (72)
40			23,050 (28)	22,100 (45)	22,750 (53)	22,000 (59)	20,200 (63)	19,000 (66.5)	18,500 (69)	18,500 (69)
45				17,550 (37)	18,250 (47.5)	18,800 (54.5)	17,800 (59.5)	17,300 (63)	17,300 (66.5)	17,300 (66.5)
50				14,050 (26.5)	14,850 (41)	15,600 (49.5)	16,000 (55.5)	16,000 (60)	16,000 (63.5)	16,000 (63.5)
55					12,200 (33.5)	12,950 (44.5)	13,650 (51)	14,100 (56.5)	14,100 (60)	14,100 (60)
60					10,050 (24)	10,850 (38.5)	11,600 (47)	12,000 (52.5)	12,000 (57)	12,000 (57)
65						9,100 (31.5)	9,900 (42)	10,250 (48.5)	10,600 (53.5)	10,600 (53.5)
70						7,650 (22.5)	8,450 (36.5)	8,820 (44.5)	9,000 (50)	9,000 (50)
75							7,210 (30)	7,580 (40)	7,800 (46.5)	7,800 (46.5)
80							6,150 (21.5)	6,490 (34.5)	6,600 (42.5)	6,600 (42.5)
85								5,500 (28.5)	5,800 (38)	5,800 (38)
90								4,730 (20.5)	5,000 (33)	5,000 (33)
95									4,270 (27.5)	4,270 (27.5)
100									3,600 (19.5)	3,600 (19.5)
									0	0
										110

NOTE: () Boom angles are in degrees. #LMI operating code. Refer to LMI manual for instructions. *This capacity is based on maximum boom angle.
Lifting capacities at zero degree boom angle

Boom angle	Main boom length in feet									
	35	40	50	**60	70	80	90	100	110	
0°	29,050 (29.8)	24,450 (34.2)	17,050 (44.2)	11,600 (54.6)	8,570 (64.2)	6,610 (74.2)	5,380 (84.2)	4,120 (94.2)	3,110 (104.2)	3,110 (104.2)

NOTE: () Reference radii in feet.
**60 ft boom length is with inner-mid extended and outer-mid & fly retracted.

A6-829-101318



36 ft – 110 ft



16,500 lb



100%
20 ft

Over rear



#0001

Feet	Main boom length in feet									
	35	40	50	**60	70	80	90	100	110	
10	120,000 (69)	84,400 (72)	80,200 (76)	*62,500 (78)						
12	100,000 (65.5)	84,400 (68.5)	80,200 (73.5)	62,500 (77)	*36,800 (78)					
15	87,300 (59.5)	82,700 (63.5)	80,200 (70)	61,000 (74)	36,800 (76.5)	*36,800 (78)	*31,000 (78)			
20	68,250 (49)	65,000 (55)	64,300 (63.5)	50,650 (69)	36,800 (72)	36,800 (75)	31,000 (77)	*29,100 (78)	*24,000 (78)	
25	55,650 (36)	53,100 (45)	52,000 (56.5)	41,800 (63.5)	36,800 (68)	34,000 (71)	30,000 (73.5)	27,000 (76)	24,000 (77.5)	24,000 (78)
30		44,100 (31.5)	39,600 (48.5)	38,000 (57.5)	33,400 (63)	29,000 (67)	25,300 (70.5)	24,200 (72.5)	22,000 (75)	22,000 (75)
35			32,400 (40)	29,750 (51.5)	28,700 (58)	25,000 (63)	22,200 (67)	21,750 (69.5)	20,000 (72)	20,000 (72)
40			26,050 (28)	25,500 (45)	23,600 (53)	22,000 (59)	20,200 (63)	19,000 (66.5)	18,500 (69)	18,500 (69)
45				20,000 (47.5)	19,700 (54.5)	18,800 (61)	17,800 (67)	17,300 (73.5)	17,300 (78)	17,300 (78)
50				17,850 (26.5)	17,850 (41)	16,800 (49.5)	16,500 (55.5)	16,000 (60)	16,000 (63.5)	16,000 (63.5)
55					14,900 (33.5)	14,650 (44.5)	14,100 (51)	14,100 (56.5)	14,100 (60)	14,100 (60)
60					13,050 (24)	12,800 (38.5)	12,200 (47)	12,200 (52.5)	12,200 (57)	12,200 (57)
65						11,450 (31.5)	10,800 (42)	10,600 (48.5)	10,600 (53.5)	10,600 (53.5)
70						10,100 (22.5)	9,450 (36.5)	9,000 (44.5)	9,000 (50)	9,000 (50)
75							8,290 (30)	7,800 (40)	7,800 (46.5)	7,800 (46.5)
80							7,140 (21.5)	6,800 (34.5)	6,600 (42.5)	6,600 (42.5)
85								5,800 (28.5)	5,800 (38)	5,800 (38)
90								5,000 (20.5)	5,000 (33)	5,000 (33)
95									4,440 (27.5)	4,440 (27.5)
100									3,880 (19.5)	3,880 (19.5)
									0	0
										110

NOTE: () Boom angles are in degrees. #LMI operating code. Refer to LMI manual for instructions. *This capacity is based on maximum boom angle.
Lifting capacities at zero degree boom angle

Boom angle	Main boom length in feet									
	35	40	50	**60	70	80	90	100	110	
0°	29,050 (29.8)	24,450 (34.2)	17,050 (44.2)	11,950 (54.6)	9,640 (64.2)	7,810 (74.2)	6,390 (84.2)	4,770 (94.2)	3,350 (104.2)	3,350 (104.2)

NOTE: () Reference radii in feet.
**60 ft boom length is with inner-mid extended and outer-mid & fly retracted.

A6-829-101319

THIS CHART IS ONLY A GUIDE AND SHOULD NOT BE USED TO OPERATE THE CRANE.

The individual crane's load chart, operating instructions and other instructional plates must be read and understood prior to operating the crane.

Load chart



Pounds						
Feet	33 ft length			56 ft length		
	#0021 0° Offset	#0022 25° Offset	#0023 45° Offset	#0041 0° Offset	#0042 25° Offset	#0043 45° Offset
30	12,900 (78)					
35	12,900 (76)			*8330 (78)		
40	12,900 (74)	*10,850 (78)		8330 (77.5)		
45	12,900 (72)	10,450 (77)	*7410 (78)	8330 (76)		
50	12,100 (70)	10,000 (74.5)	7200 (77.5)	8330 (74.5)		
55	11,100 (68)	9220 (72.5)	6990 (75)	8250 (73)	*5300 (78)	
60	10,100 (66)	8550 (70.5)	6800 (72.5)	7540 (71)	5140 (77)	
65	9130 (63.5)	7930 (68)	6650 (70.5)	7160 (69)	5100 (75)	*3860 (78)
70	8460 (61.5)	7380 (65.5)	6490 (68)	6820 (67.5)	5100 (73)	3790 (77.5)
75	7840 (59)	6900 (63)	6370 (65.5)	6300 (65.5)	4800 (71)	3660 (75)
80	7230 (56.5)	6470 (60.5)	6110 (62.5)	5810 (63.5)	4580 (69)	3550 (73)
85	6470 (54)	6070 (58)	5780 (60)	5370 (61.5)	4470 (67.5)	3450 (71)
90	5670 (51)	5720 (55.5)	5480 (57)	4980 (59.5)	4330 (65.5)	3410 (68.5)
95	4970 (48.5)	5400 (52.5)	5200 (54)	4630 (57)	4070 (63)	3300 (66.5)
100	4350 (45.5)	4840 (49.5)	4950 (51)	4320 (55)	3830 (61)	3260 (64)
105	3790 (42.5)	4210 (46.5)	4470 (47.5)	4040 (52.5)	3620 (58.5)	3220 (62)
110	3290 (39.5)	3640 (43)		3760 (50.5)	3410 (56)	3180 (59.5)
115	2830 (36)	3130 (39.5)		3290 (48)	3230 (53.5)	3060 (56.5)
120	2420 (32)	2660 (35)		2860 (45.5)	3050 (51)	2940 (53.5)
125	2040 (27.5)	2240 (30.5)		2470 (42.5)	2890 (48.5)	2800 (50.5)
130	1700 (22)			2120 (39.5)	2590 (45.5)	
135				1790 (36.5)	2200 (42.5)	
140				1480 (33)	1840 (38.5)	
145				1200 (29.5)	1500 (34.5)	
No load stability data						
Min. boom angle for indicated length	21°	25°	45°	28°	28°	45°
Max. boom length at 0° boom angle		100 ft			90 ft	

NOTE: () Boom angles are in degrees.

A6-829-101337

*This capacity is based upon maximum boom angle.

#LMI operating code. Refer to LMI manual for instructions.

NOTES:

1. All capacities above the bold line are based on structural strength of boom extension.
2. 33 ft and 56 ft boom extension lengths may be used for single line lifting service.
3. Radii listed are for a fully extended boom with the boom extension erected. For main boom lengths less than fully extended, the rated loads are determined by boom angle. Use only the column which corresponds to the boom extension length and offset for which the machine is configured. For boom angles not shown, use the rating of the next lower boom angle.
4. **WARNING:** Operation of this machine with heavier loads than the capacities listed is strictly prohibited. Machine tipping with boom extension occurs rapidly and without advance warning.
5. Boom angle is the angle above or below horizontal of the longitudinal axis of the boom base section after lifting rated load.
6. Capacities listed are with outriggers properly extended and vertical jacks set only.

TMS760E load charts



#0101									
Feet	Main boom length in feet								
	35	40	50	**60	70	80	90	100	110
10	120,000 (69)	84,400 (72)	80,200 (76)	*62,500 (78)					
12	100,000 (65.5)	84,400 (68.5)	80,200 (73.5)	62,500 (77)	*36,800 (78)				
15	87,300 (59.5)	82,700 (63.5)	80,200 (70)	61,000 (63.5)	36,800 (74)	*36,800 (76.5)	*31,000 (78)		
20	68,250 (49)	65,000 (55)	64,300 (63.5)	50,650 (69)	36,800 (72)	36,800 (75)	31,000 (77)	*29,100 (78)	*24,000 (78)
25	48,550 (36)	48,350 (45)	47,650 (56.5)	41,800 (63.5)	36,800 (68)	34,000 (71)	30,000 (73.5)	27,000 (76)	24,000 (77.5)
30		34,300 (31.5)	33,650 (48.5)	32,800 (57.5)	33,400 (63)	29,000 (67)	25,300 (70.5)	24,200 (72.5)	22,000 (75)
35			25,250 (40)	24,350 (51.5)	25,000 (58)	25,000 (63)	22,200 (67)	21,750 (69.5)	20,000 (72)
40			19,500 (28)	18,700 (45)	19,350 (53)	20,050 (59)	20,200 (63)	19,000 (66.5)	18,500 (69)
45				14,650 (37)	15,350 (47.5)	16,050 (54.5)	16,750 (59.5)	17,300 (63)	17,300 (66.5)
50				11,550 (26.5)	12,350 (41)	13,050 (49.5)	13,750 (55.5)	14,300 (60)	14,850 (63.5)
55					9,960 (33.5)	10,700 (44.5)	11,450 (51)	11,900 (56.5)	12,400 (60)
60					8,040 (24)	8,850 (38.5)	9,590 (47)	10,000 (52.5)	10,400 (57)
65						7,280 (31.5)	8,070 (42)	8,450 (48.5)	8,830 (53.5)
70						5,970 (22.5)	6,760 (36.5)	7,140 (44.5)	7,480 (50)
75							5,660 (30)	6,020 (40)	6,350 (46.5)
80							4,710 (21.5)	5,050 (34.5)	5,370 (42.5)
85								4,200 (28.5)	4,510 (38)
90								3,460 (20.5)	3,750 (33)
95									3,080 (27.5)
100									2,480 (19.5)
Minimum boom angle (deg) for indicated length (no load)									
Maximum boom length (ft) at 0 degree boom angle (no load)									
NOTE: () Boom angles are in degrees. #LMI operating code. Refer to LMI manual for instructions. *This capacity is based on maximum boom angle. Lifting capacities at zero degree boom angle									
Main boom length in feet									
Boom angle	35	40	50	**60	70	80	90	100	110
0°	29,050 (29.8)	24,450 (34.2)	16,000 (44.2)	9,340 (54.6)	6,710 (64.2)	5,030 (74.2)	4,020 (84.2)	2,920 (94.2)	2,030 (104.2)
NOTE: () Reference radii in feet.									
**60 ft boom length is with inner-mid extended and outer-mid & fly retracted.									

A6-829-101320



#0101									
Feet	Main boom length in feet								
	35	40	50	**60	70	80	90	100	110
10	120,000 (69)	84,400 (72)	80,200 (76)	*62,500 (78)					
12	100,000 (65.5)	84,400 (68.5)	80,200 (73.5)	62,500 (77)	*36,800 (78)				
15	87,300 (59.5)	82,700 (63.5)	80,200 (70)	61,000 (63.5)	36,800 (74)	*36,800 (76.5)	*31,000 (78)		
20	68,250 (49)	65,000 (55)	64,300 (63.5)	50,650 (69)	36,800 (72)	36,800 (75)	31,000 (77)	*29,100 (78)	*24,000 (78)
25	52,900 (36)	52,700 (45)	52,000 (56.5)	41,800 (63.5)	36,800 (68)	34,000 (71)	30,000 (73.5)	27,000 (76)	24,000 (77.5)
30		41,750 (31.5)	39,600 (48.5)	38,000 (57.5)	33,400 (63)	29,000 (67)	25,300 (70.5)	24,200 (72.5)	22,000 (75)
35			32,400 (40)	29,750 (51.5)	28,700 (58)	25,000 (63)	22,200 (67)	21,750 (69.5)	20,000 (72)
40			26,050 (28)	25,500 (45)	23,600 (53)	22,000 (59)	20,200 (63)	19,000 (66.5)	18,500 (69)
45				20,000 (47)	19,700 (47.5)	18,800 (54.5)	17,800 (59.5)	17,300 (63)	17,300 (66.5)
50				16,650 (26.5)	16,800 (41)	16,500 (49.5)	16,000 (55.5)	16,000 (60)	16,000 (63.5)
55					14,500 (33.5)	14,650 (44.5)	14,100 (51)	14,100 (56.5)	14,100 (60)
60					12,100 (32)	12,800 (47)	12,200 (38.5)	12,200 (47)	12,200 (52.5)
65						10,950 (31.5)	10,800 (42)	10,600 (48.5)	10,600 (53.5)
70						9,290 (22.5)	9,450 (36.5)	9,000 (44.5)	9,000 (50)
75							8,290 (30)	7,800 (40)	7,800 (46.5)
80							7,140 (21.5)	6,600 (34.5)	6,600 (42.5)
85								5,800 (28.5)	5,800 (38)
90								5,000 (20.5)	5,000 (33)
95									4,440 (27.5)
100									3,800 (19.5)
Minimum boom angle (deg) for indicated length (no load)									
Maximum boom length (ft) at 0 degree boom angle (no load)									
NOTE: () Boom angles are in degrees. #LMI operating code. Refer to LMI manual for instructions. *This capacity is based on maximum boom angle. Lifting capacities at zero degree boom angle									
Main boom length in feet									
Boom angle	35	40	50	**60	70	80	90	100	110
0°	29,050 (29.8)	24,450 (34.2)	17,050 (44.2)	11,950 (54.6)	9,640 (64.2)	7,810 (74.2)	6,390 (84.2)	4,770 (94.2)	3,350 (104.2)
NOTE: () Reference radii in feet.									
**60 ft boom length is with inner-mid extended and outer-mid & fly retracted.									

A6-829-101321

THIS CHART IS ONLY A GUIDE AND SHOULD NOT BE USED TO OPERATE THE CRANE.

The individual crane's load chart, operating instructions and other instructional plates must be read and understood prior to operating the crane.

Load chart



Pounds						
Feet	33 ft length			56 ft length		
	#0121 0° Offset	#0122 25° Offset	#0123 45° Offset	#0141 0° Offset	#0142 25° Offset	#0143 45° Offset
30	12,900 (78)					
35	12,900 (76)			*8330 (78)		
40	12,900 (74)	*10,850 (78)		8330 (77.5)		
45	12,900 (72)	10,450 (77)	*7410 (78)	8330 (76)		
50	12,100 (70)	10,000 (74.5)	7200 (77.5)	8330 (74.5)		
55	11,100 (68)	9220 (72.5)	6990 (75)	8250 (73)	*5300 (78)	
60	10,100 (66)	8550 (70.5)	6800 (72.5)	7540 (71)	5140 (77)	
65	9130 (63.5)	7930 (68)	6650 (70.5)	7160 (69)	5100 (75)	*3860 (78)
70	7960 (61.5)	7380 (65.5)	6490 (68)	6820 (67.5)	5100 (73)	3790 (77.5)
75	6870 (59)	6900 (63)	6370 (65.5)	6300 (65.5)	4800 (71)	3660 (75)
80	5930 (56.5)	6470 (60.5)	6110 (62.5)	5810 (63.5)	4580 (69)	3550 (73)
85	5120 (54)	5880 (58)	5780 (60)	5370 (61.5)	4470 (67.5)	3450 (71)
90	4410 (51)	5070 (55.5)	5440 (57)	4960 (59.5)	4330 (65.5)	3410 (68.5)
95	3780 (48.5)	4350 (52.5)	4680 (54)	4310 (57)	4070 (63)	3300 (66.5)
100	3230 (45.5)	3710 (49.5)	4010 (51)	3730 (55)	3830 (61)	3260 (64)
105	2730 (42.5)	3140 (46.5)	3410 (47.5)	3210 (52.5)	3620 (58.5)	3220 (62)
110	2280 (39.5)	2630 (43)		2750 (50.5)	3410 (56)	3180 (59.5)
115	1870 (36)	2170 (39.5)		2330 (48)	3020 (53.5)	3060 (56.5)
120	1500 (32)	1750 (35)		1940 (45.5)	2550 (51)	2800 (53.5)
125	1170 (27.5)	1360 (30.5)		1590 (42.5)	2130 (48.5)	2330 (50.5)
130				1270 (39.5)	1740 (45.5)	
135					1390 (42.5)	
140					1060 (38.5)	

No load stability data

Min. boom angle for indicated length	25°	25°	45°	33°	36°	45°
Max. boom length at 0° boom angle		90 ft			80 ft	

NOTE: () Boom angles are in degrees.

A6-829-101338

*This capacity is based upon maximum boom angle.

#LMI operating code. Refer to LMI manual for instructions.

NOTES:

- All capacities above the bold line are based on structural strength of boom extension.
- 33 ft and 56 ft boom extension lengths may be used for single line lifting service.
- Radii listed are for a fully extended boom with the boom extension erected. For main boom lengths less than fully extended, the rated loads are determined by boom angle. Use only the column which corresponds to the boom extension length and offset for which the machine is configured. For boom angles not shown, use the rating of the next lower boom angle.
- WARNING:** Operation of this machine with heavier loads than the capacities listed is strictly prohibited. Machine tipping with boom extension occurs rapidly and without advance warning.
- Boom angle is the angle above or below horizontal of the longitudinal axis of the boom base section after lifting rated load.
- Capacities listed are with outriggers properly extended and vertical jacks set only.

TMS760E load charts





36 ft – 110 ft **5500 lb** **100% 20 ft** **360°**

#0201									
Feet	Main boom length in feet								
	35	40	50	**60	70	80	90	100	110
10	118,500 (63)	84,400 (72)	80,200 (76)	*62,500 (78)					
12	100,000 (65.5)	84,400 (68.5)	80,200 (73.5)	62,500 (77)	*36,800 (78)				
15	87,300 (59.5)	82,700 (63.5)	80,200 (70)	61,000 (74)	36,800 (76.5)	*36,800 (78)	*31,000 (78)		
20	66,000 (49)	65,000 (55)	64,300 (63.5)	50,650 (69)	36,800 (72)	36,800 (75)	31,000 (77)	*29,100 (78)	*24,000 (78)
25	41,100 (36)	41,000 (45)	40,600 (56.5)	40,150 (63.5)	36,800 (68)	34,000 (71)	30,000 (73.5)	27,000 (76)	24,000 (77.5)
30		28,400 (31.5)	28,150 (48.5)	27,750 (57.5)	28,450 (63)	29,000 (67)	25,300 (70.5)	24,200 (72.5)	22,000 (75)
35			20,700 (40)	20,300 (51.5)	21,000 (58)	21,750 (63)	22,200 (67)	21,750 (69.5)	20,000 (72)
40			15,600 (28)	15,350 (45)	16,050 (53)	16,750 (59)	17,500 (63)	17,900 (66.5)	18,300 (69)
45				11,750 (37)	12,500 (47.5)	13,200 (54.5)	13,950 (59.5)	14,300 (63)	14,700 (66.5)
50				9040 (26.5)	9850 (41)	10,550 (49.5)	11,250 (55.5)	11,650 (60)	12,000 (63.5)
55					7720 (33.5)	8500 (44.5)	9210 (51)	9570 (56.5)	9940 (60)
60					6010 (24)	6810 (38.5)	7550 (47)	7900 (52.5)	8260 (57)
65						5410 (31.5)	6190 (42)	6540 (48.5)	6880 (53.5)
70						4250 (22.5)	5020 (36.5)	5400 (44.5)	5740 (50)
75							4030 (30)	4420 (40)	4770 (46.5)
80							3190 (21.5)	3570 (34.5)	3940 (42.5)
85								2830 (28.5)	3200 (38)
90								2180 (20.5)	2550 (33)
95									1980 (27.5)
100									1470 (19.5)
									0
									110

NOTE: () Boom angles are in degrees. #LMI operating code. Refer to LMI manual for instructions. *This capacity is based on maximum boom angle. Lifting capacities at zero degree boom angle.

Boom angle	Main boom length in feet								
	35	40	50	**60	70	80	90	100	110
0°	28,850 (29.8)	21,800 (34.2)	12,500 (44.2)	7080 (54.6)	4830 (64.2)	3410 (74.2)	2570 (84.2)	1710 (94.2)	1080 (104.2)

NOTE: () Reference radii in feet. *60 ft boom length is with inner-mid extended and outer-mid & fly retracted.

A6-829-101322





36 ft – 110 ft **5500 lb** **100% 20 ft** **Over rear**

#0201									
Feet	Main boom length in feet								
	35	40	50	**60	70	80	90	100	110
10	120,000 (63)	84,400 (72)	80,200 (76)	*62,500 (78)					
12	100,000 (65.5)	84,400 (68.5)	80,200 (73.5)	62,500 (77)	*36,800 (78)				
15	87,300 (59.5)	82,700 (63.5)	80,200 (70)	61,000 (74)	36,800 (76.5)	*36,800 (78)	*31,000 (78)		
20	66,000 (49)	65,000 (55)	64,300 (63.5)	50,650 (69)	36,800 (72)	36,800 (75)	31,000 (77)	*29,100 (78)	*24,000 (78)
25	41,100 (36)	41,000 (45)	40,600 (56.5)	41,800 (63.5)	38,000 (68)	34,000 (71)	30,000 (73.5)	27,000 (76)	24,000 (77.5)
30		38,100 (31.5)	38,200 (48.5)	38,000 (57.5)	33,400 (63)	29,000 (67)	25,300 (70.5)	24,200 (72.5)	22,000 (75)
35			28,700 (40)	28,600 (51.5)	28,700 (58)	25,000 (63)	22,200 (67)	21,750 (69.5)	20,000 (72)
40			22,200 (28)	22,200 (45)	23,000 (53)	22,000 (59)	20,200 (63)	19,000 (66.5)	18,500 (69)
45				17,600 (37)	18,400 (47.5)	18,800 (54.5)	17,800 (59.5)	17,300 (63)	17,300 (66.5)
50				14,100 (26.5)	14,950 (41)	15,750 (49.5)	16,000 (55.5)	16,000 (60)	16,000 (63.5)
55					12,250 (33.5)	13,050 (44.5)	13,800 (51)	14,100 (56.5)	14,100 (60)
60					10,050 (24)	10,900 (38.5)	11,650 (47)	12,000 (52.5)	12,200 (57)
65						9100 (31.5)	9890 (42)	10,200 (48.5)	10,550 (53.5)
70						7590 (22.5)	8380 (36.5)	8740 (44.5)	9000 (50)
75							7100 (30)	7480 (40)	7800 (46.5)
80							5990 (21.5)	6370 (34.5)	6600 (42.5)
85								5410 (28.5)	5770 (38)
90								4570 (20.5)	4920 (33)
95									4180 (27.5)
100									3520 (19.5)
									0
									110

NOTE: () Boom angles are in degrees. #LMI operating code. Refer to LMI manual for instructions. *This capacity is based on maximum boom angle. Lifting capacities at zero degree boom angle.

Boom angle	Main boom length in feet								
	35	40	50	**60	70	80	90	100	110
0°	29,050 (29.8)	24,450 (34.2)	17,050 (44.2)	11,600 (54.6)	8550 (64.2)	6520 (74.2)	5190 (84.2)	3950 (94.2)	3020 (104.2)

NOTE: () Reference radii in feet. *60 ft boom length is with inner-mid extended and outer-mid & fly retracted.

A6-829-101323

THIS CHART IS ONLY A GUIDE AND SHOULD NOT BE USED TO OPERATE THE CRANE.

The individual crane's load chart, operating instructions and other instructional plates must be read and understood prior to operating the crane.

Load chart



		Pounds					
		33 ft length			56 ft length		
Feet	0°	#0221	#0222	#0223	#0241	#0242	#0243
		Offset	Offset	Offset	Offset	Offset	Offset
30	12,900 (78)						
35	12,900 (76)				*8330 (78)		
40	12,900 (74)	*10,850 (78)			8330 (77.5)		
45	12,900 (72)	10,450 (77)	*7410 (78)		8330 (76)		
50	12,100 (70)	10,000 (74.5)	7200 (77.5)		8330 (74.5)		
55	10,450 (68)	9220 (72.5)	6990 (75)		8250 (73)	*5300 (78)	
60	8780 (66)	8550 (70.5)	6800 (72.5)		7540 (71)	5140 (77)	
65	7420 (63.5)	7930 (68)	6650 (70.5)		7160 (69)	5100 (75)	*3860 (78)
70	6280 (61.5)	7260 (65.5)	6490 (68)		6820 (67.5)	5100 (73)	3790 (77.5)
75	5310 (59)	6180 (63)	6370 (65.5)		6030 (65.5)	4800 (71)	3660 (75)
80	4490 (56.5)	5250 (60.5)	5840 (62.5)		5150 (63.5)	4580 (69)	3550 (73)
85	3770 (54)	4450 (58)	4950 (60)		4400 (61.5)	4470 (67.5)	3450 (71)
90	3150 (51)	3750 (55.5)	4180 (57)		3730 (59.5)	4330 (65.5)	3410 (68.5)
95	2590 (48.5)	3130 (52.5)	3490 (54)		3140 (57)	4070 (63)	3300 (66.5)
100	2100 (45.5)	2580 (49.5)	2890 (51)		2620 (55)	3590 (61)	3260 (64)
105	1660 (42.5)	2080 (46.5)	2340 (47.5)		2160 (52.5)	3030 (58.5)	3220 (62)
110	1270 (39.5)	1640 (43)			1740 (50.5)	2520 (56)	2880 (59.5)
115		1240 (39.5)			1360 (48)	2050 (53.5)	2360 (56.5)
120					1010 (45.5)	1640 (51)	1890 (53.5)
125						1250 (48.5)	1450 (50.5)
No load stability data							
Min. boom angle for indicated length	37°	37°	45°	45°	46°	48°	
Max. boom length at 0° boom angle	80 ft			60 ft			

NOTE: () Boom angles are in degrees. A6-829-101339
 *This capacity is based upon maximum boom angle.
 #IMI operating code. Refer to IMI manual for instructions.

NOTES:

1. All capacities above the bold line are based on structural strength of boom extension.
2. 33 ft and 56 ft boom extension lengths may be used for single line lifting service.
3. Radii listed are for a fully extended boom with the boom extension erected. For main boom lengths less than fully extended, the rated loads are determined by boom angle. Use only the column which corresponds to the boom extension length and offset for which the machine is configured. For boom angles not shown, use the rating of the next lower boom angle.
4. **WARNING:** Operation of this machine with heavier loads than the capacities listed is strictly prohibited. Machine tipping with boom extension occurs rapidly and without advance warning.
5. Boom angle is the angle above or below horizontal of the longitudinal axis of the boom base section after lifting rated load.
6. Capacities listed are with outriggers properly extended and vertical jacks set only.

TMS760E load charts





36 ft – 110 ft 0 lb 100% 20 ft 360°

#0801											
Feet	Main boom length in feet										
	35	40	50	**60	70	80	90	100	110		
10	117,500 (69)	84,400 (72)	80,200 (76)	*62,500 (78)							
12	100,000 (65.5)	84,400 (68.5)	80,200 (73.5)	62,500 (77)	*36,800 (78)						
15	87,300 (59.5)	82,700 (63.5)	80,200 (70)	61,000 (74)	36,800 (76.5)	*36,800 (78)	*31,000 (78)				
20	56,000 (49)	55,750 (55)	55,300 (63.5)	50,650 (69)	36,800 (72)	36,800 (75)	31,000 (77)	*29,100 (78)	*24,000 (78)		
25	34,350 (36)	34,300 (45)	33,850 (56.5)	33,400 (63.5)	34,100 (68)	34,000 (71)	30,000 (73.5)	27,000 (76)	24,000 (77.5)		
30		23,350 (31.5)	23,100 (48.5)	22,700 (57.5)	23,400 (63)	24,150 (67)	24,850 (70.5)	24,200 (72.5)	22,000 (75)		
35			16,650 (40)	16,250 (51.5)	16,950 (58)	17,700 (63)	18,400 (67)	18,850 (69.5)	19,300 (72)		
40			12,250 (28)	12,000 (45)	12,650 (53)	13,400 (59)	14,100 (63)	14,550 (66.5)	14,950 (69)		
45				8890 (37)	9620 (47.5)	10,300 (54.5)	11,050 (59.5)	11,450 (63)	11,800 (66.5)		
50				6510 (26.5)	7330 (41)	8040 (49.5)	8750 (55.5)	9130 (60)	9510 (63.5)		
55					5470 (33.5)	6250 (44.5)	6960 (51)	7320 (56.5)	7690 (60)		
60					3930 (24)	4700 (38.5)	5530 (47)	5880 (52.5)	6240 (57)		
65						3580 (31.5)	4350 (42)	4700 (48.5)	5050 (53.5)		
70						2560 (22.5)	3340 (36.5)	3710 (44.5)	4060 (48.5)		
75							2480 (30)	2870 (40)	3220 (46.5)		
80							1740 (21.5)	2130 (34.5)	2500 (42.5)		
85								1480 (28.5)	1850 (38)		
90									1290 (33)		
Minimum boom angle (deg) for indicated length (no load)									14	26	
Maximum boom length (ft) at 0 degree boom angle (no load)										90	
NOTE: () Boom angles are in degrees. #LMI operating code. Refer to LMI manual for instructions. *This capacity is based on maximum boom angle.											
Lifting capacities at zero degree boom angle											
Main boom length in feet											
Boom angle	35	40	50	**60	70	80	90				
0°	23,700 (29.8)	17,650 (34.2)	9550 (44.2)	4810 (54.6)	2960 (64.2)	1840 (74.2)	1210 (84.2)				
NOTE: () Reference radii in feet.											
**60 ft boom length is with inner-mid extended and outer-mid & fly retracted.											

A6-829-101324





36 ft – 110 ft 0 lb 100% 20 ft Over rear

#0801											
Feet	Main boom length in feet										
	35	40	50	**60	70	80	90	100	110		
10	120,000 (69)	84,400 (72)	80,200 (76)	*62,500 (78)							
12	100,000 (65.5)	84,400 (68.5)	80,200 (73.5)	62,500 (77)	*36,800 (78)						
15	87,300 (59.5)	82,700 (63.5)	80,200 (70)	61,000 (74)	36,800 (76.5)	*36,800 (78)	*31,000 (78)				
20	62,400 (49)	62,200 (55)	61,800 (63.5)	50,650 (69)	36,800 (72)	36,800 (75)	31,000 (77)	*29,100 (78)	*24,000 (78)		
25	47,250 (36)	47,050 (45)	46,700 (56.5)	41,800 (63.5)	36,800 (68)	34,000 (71)	30,000 (73.5)	27,000 (76)	24,000 (77.5)		
30		32,950 (31.5)	33,100 (48.5)	33,050 (57.5)	33,400 (63)	29,000 (67)	25,300 (70.5)	24,200 (72.5)	22,000 (75)		
35			24,600 (40)	24,500 (51.5)	25,350 (58)	25,000 (63)	22,200 (67)	21,750 (69.5)	20,000 (72)		
40			18,800 (28)	18,750 (45)	19,600 (53)	20,450 (59)	20,200 (63)	19,000 (66.5)	18,500 (69)		
45				14,650 (37)	15,500 (47.5)	16,300 (54.5)	17,100 (59.5)	17,300 (63)	17,300 (66.5)		
50				11,550 (26.5)	12,400 (41)	13,200 (49.5)	14,000 (55.5)	14,350 (60)	14,750 (63.5)		
55					9990 (33.5)	10,800 (44.5)	11,550 (51)	11,900 (56.5)	12,300 (60)		
60					8020 (24)	8660 (38.5)	9620 (47)	9980 (52.5)	10,300 (57)		
65						7240 (31.5)	8030 (42)	8370 (48.5)	8720 (53.5)		
70						5890 (22.5)	6680 (36.5)	7040 (44.5)	7380 (50)		
75							5520 (30)	5910 (40)	6240 (46.5)		
80							4540 (21.5)	4910 (34.5)	5270 (42.5)		
85								4050 (28.5)	4410 (38)		
90								3300 (20.5)	3650 (33)		
95									2980 (27.5)		
100									2380 (19.5)		
Minimum boom angle (deg) for indicated length (no load)									0	0	
Maximum boom length (ft) at 0 degree boom angle (no load)										110	
NOTE: () Boom angles are in degrees. #LMI operating code. Refer to LMI manual for instructions. *This capacity is based on maximum boom angle.											
Lifting capacities at zero degree boom angle											
Main boom length in feet											
Boom angle	35	40	50	**60	70	80	90	100	110		
0°	29,050 (29.8)	24,450 (34.2)	15,250 (44.2)	9320 (54.6)	6660 (64.2)	4930 (74.2)	3820 (84.2)	2740 (94.2)	1940 (104.2)		
NOTE: () Reference radii in feet.											
**60 ft boom length is with inner-mid extended and outer-mid & fly retracted.											

A6-829-101325

THIS CHART IS ONLY A GUIDE AND SHOULD NOT BE USED TO OPERATE THE CRANE.

The individual crane's load chart, operating instructions and other instructional plates must be read and understood prior to operating the crane.

Load chart



Pounds						
Feet	33 ft length			56 ft length		
	#0821 0° Offset	#0822 25° Offset	#0823 45° Offset	#0841 0° Offset	#0842 25° Offset	#0843 45° Offset
30	12,900 (78)					
35	12,900 (76)			*8330 (78)		
40	12,900 (74)	*10,850 (78)		8330 (77.5)		
45	12,800 (72)	10,450 (77)	*7410 (78)	8330 (76)		
50	10,350 (70)	10,000 (74.5)	7200 (77.5)	8330 (74.5)		
55	8510 (68)	9220 (72.5)	6990 (75)	8250 (73)	*5300 (78)	
60	7000 (66)	8330 (70.5)	6800 (72.5)	7540 (71)	5140 (77)	
65	5770 (63.5)	6930 (68)	6650 (70.5)	6420 (69)	5100 (75)	*3860 (78)
70	4740 (61.5)	5760 (65.5)	6370 (68)	5370 (67.5)	5100 (73)	3790 (77.5)
75	3870 (59)	4770 (63)	5310 (65.5)	4480 (65.5)	4800 (71)	3660 (75)
80	3130 (56.5)	3920 (60.5)	4390 (62.5)	3710 (63.5)	4580 (69)	3550 (73)
85	2480 (54)	3180 (58)	3610 (60)	3050 (61.5)	4110 (67.5)	3450 (71)
90	1920 (51)	2540 (55.5)	2910 (57)	2470 (59.5)	3450 (65.5)	3410 (68.5)
95	1420 (48.5)	1970 (52.5)	2310 (54)	1960 (57)	2860 (63)	3300 (66.5)
100		1470 (49.5)	1760 (51)	1500 (55)	2330 (61)	2980 (64)
105		1020 (46.5)	1280 (47.5)	1090 (52.5)	1870 (58.5)	2390 (62)
110					1450 (56)	1870 (59.5)
115					1060 (53.5)	1400 (56.5)
No load stability data						
Min. boom angle for indicated length	46°	45°	45°	48°	51°	51°
Max. boom length at 0° boom angle	60 ft			50 ft		

NOTE: () Boom angles are in degrees.

A6-829-101340

*This capacity is based upon maximum boom angle.

#LMI operating code. Refer to LMI manual for instructions.

NOTES:

1. All capacities above the bold line are based on structural strength of boom extension.
2. 33 ft and 56 ft boom extension lengths may be used for single line lifting service.
3. Radii listed are for a fully extended boom with the boom extension erected. For main boom lengths less than fully extended, the rated loads are determined by boom angle. Use only the column which corresponds to the boom extension length and offset for which the machine is configured. For boom angles not shown, use the rating of the next lower boom angle.
4. **WARNING:** Operation of this machine with heavier loads than the capacities listed is strictly prohibited. Machine tipping with boom extension occurs rapidly and without advance warning.
5. Boom angle is the angle above or below horizontal of the longitudinal axis of the boom base section after lifting rated load.
6. Capacities listed are with outriggers properly extended and vertical jacks set only.

THIS CHART IS ONLY A GUIDE AND SHOULD NOT BE USED TO OPERATE THE CRANE.

Working range

36 ft – 110 ft main boom and 33 ft – 56 ft lattice extension with 40 ft insert

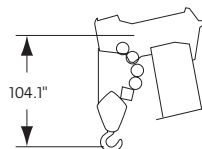
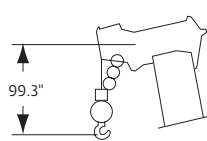
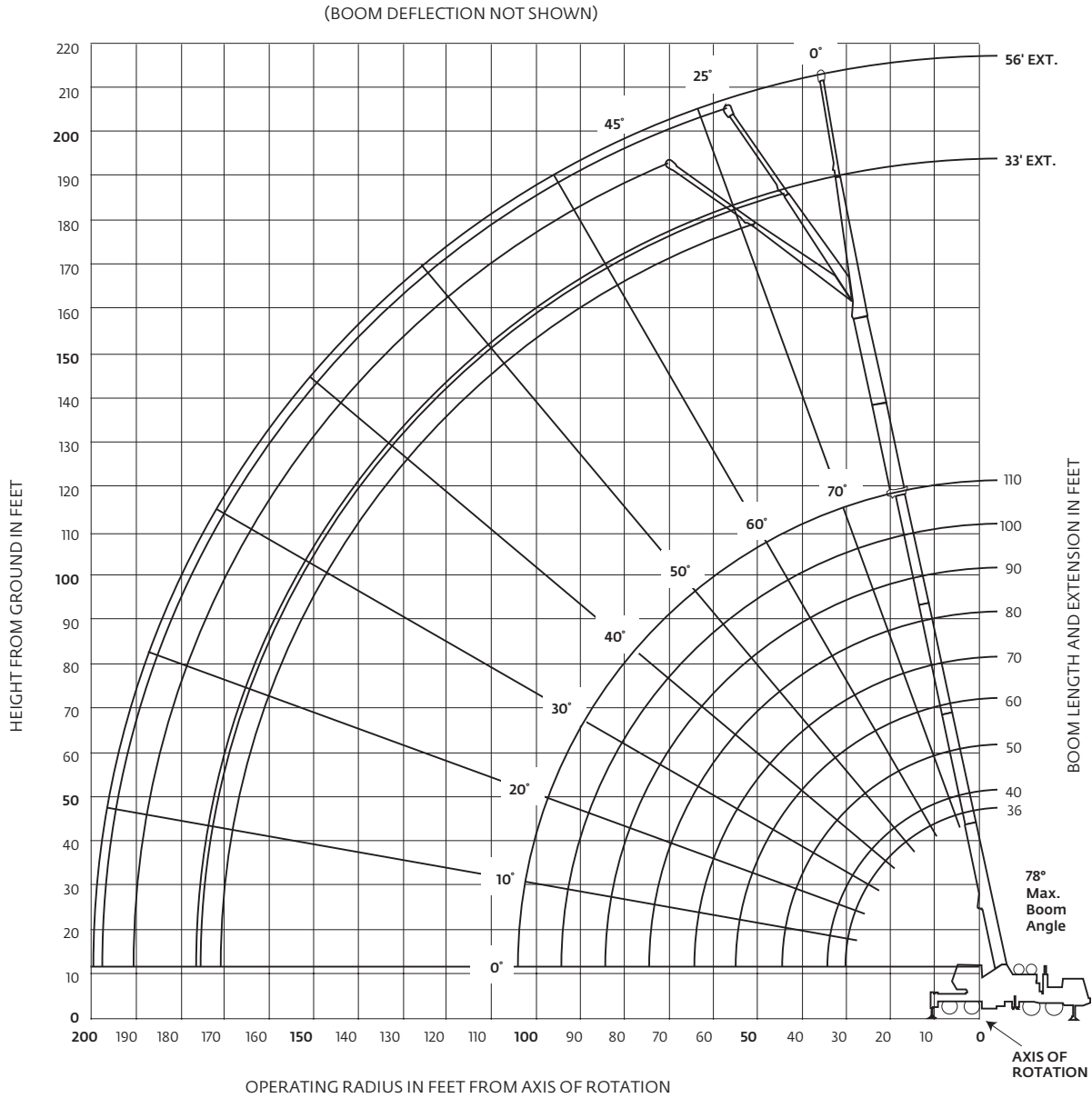

Dimensions are for largest Grove furnished hook block and headache ball, with anti-two block activated.

Load chart

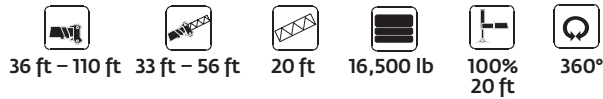

		Pounds					
Feet	0° Offset	33 ft length			56 ft length		
		#0064 25° Offset	#0065 45° Offset	#0066 Offset	#0084 0° Offset	#0085 25° Offset	#0086 45° Offset
35	*9360 (78)						
40	9360 (77.5)				*6300 (78)		
45	8480 (76)	*7480 (78)			6300 (77.5)		
50	7680 (74)	7070 (77.5)			6000 (77)		
55	6990 (72)	6470 (76)	5880 (78)		5990 (75.5)		
60	6390 (70)	5970 (74)	5480 (76.5)		5980 (73.5)	*4840 (78)	
65	5890 (68.5)	5570 (72.5)	5080 (74.5)		5510 (72)	4840 (77.5)	
70	5390 (66.5)	5070 (70.5)	4780 (72.5)		5010 (70.5)	4440 (76.5)	
75	4990 (64.5)	4770 (68.5)	4480 (70.5)		4560 (68.5)	4050 (75)	*3760 (78)
80	4650 (62.5)	4400 (66)	4190 (68)		4170 (67)	3870 (73)	3460 (77)
85	4300 (60)	4150 (64)	3890 (66)		3820 (65)	3570 (71.5)	3260 (75)
90	4000 (58)	3850 (62)	3690 (63.5)		3520 (63.5)	3320 (69.5)	2960 (73)
95	3760 (56)	3650 (59.5)	3500 (61.5)		3220 (61.5)	3070 (67.5)	2770 (71)
100	3510 (53.5)	3410 (57.5)	3300 (59)		2980 (59.5)	2880 (66)	2570 (69)
105	3260 (51)	3210 (55)	3100 (56.5)		2780 (58)	2680 (64)	2460 (67)
110	3070 (48.5)	3020 (52.5)	2930 (54)		2530 (56)	2480 (62)	2340 (65)
115	2870 (46)	2870 (50)	2780 (51)		2340 (54)	2280 (60)	2200 (63)
120	2550 (43.5)	2730 (47)			2190 (52)	2140 (57.5)	2050 (60.5)
125	2170 (40.5)	2500 (44)			2000 (49.5)	1990 (55.5)	1910 (58)
130	1820 (37.5)	2100 (41)			1850 (47.5)	1850 (53)	1810 (55.5)
135	1500 (34.5)	1730 (37.5)			1720 (45)	1750 (51)	1670 (53)
140	1210 (30.5)	1390 (33.5)			1480 (42.5)	1610 (48.5)	
145						1520 (45.5)	
150						1370 (43)	
No load stability data							
Min. boom angle at 110 ft boom length	22°	29°	45°	38°	40°	45°	
Max. boom length at 0° boom angle		100 ft			80 ft		

NOTE: () Boom angles are in degrees. A6-829-101484
 *This capacity is based upon maximum boom angle.
 #LMI operating code. Refer to LMI manual for instructions.

NOTES:

- All capacities above the bold line are based on structural strength of boom extension.
- 33 ft and 56 ft boom extension lengths may be used for single line lifting service.
- Radii listed are for a fully extended boom with the boom extension erected. For main boom lengths less than fully extended, the rated loads are determined by boom angle. Use only the column which corresponds to the boom extension length and offset for which the machine is configured. For boom angles not shown, use the rating of the next lower boom angle.
- WARNING:** Operation of this machine with heavier loads than the capacities listed is strictly prohibited. Machine tipping with boom extension occurs rapidly and without advance warning.
- Boom angle is the angle above or below horizontal of the longitudinal axis of the boom base section after lifting rated load.
- Capacities listed are with outriggers properly extended and vertical jacks set only.

THIS CHART IS ONLY A GUIDE AND SHOULD NOT BE USED TO OPERATE THE CRANE.

Load chart

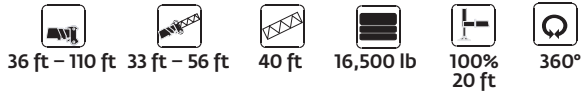

Pounds						
Feet	33 ft Length			56 ft Length		
	#0064	#0065	#0066	#0084	#0085	#0086
	0° Offset	25° Offset	45° Offset	0° Offset	25° Offset	45° Offset
45	6560 (78)					
50	5960 (76)			4510 (78)		
55	5360 (74.5)	5860 (78)		4210 (77.5)		
60	4860 (73)	5260 (76.5)	*5170 (78)	3910 (76)		
65	4370 (71)	4870 (75)	4670 (77.5)	3710 (74.5)		
70	3970 (69.5)	4370 (73)	4270 (75.5)	3410 (73)	*3710 (78)	
75	3670 (67.5)	4070 (71.5)	3980 (73.5)	3220 (71.5)	3420 (77.5)	
80	3270 (66)	3670 (69.5)	3680 (72)	2820 (70)	3120 (76)	
85	2980 (64)	3370 (68)	3380 (70)	2520 (68.5)	2820 (74.5)	2730 (77.5)
90	2780 (62.5)	3080 (66)	3080 (68)	2320 (66.5)	2620 (72.5)	2530 (76)
95	2480 (60.5)	2880 (64)	2890 (66)	2030 (65)	2330 (71)	2340 (74.5)
100	2290 (58.5)	2580 (62)	2690 (64)	1830 (63.5)	2130 (69.5)	2140 (72.5)
105	2090 (56.5)	2390 (60)	2390 (62)	1630 (62)	1930 (68)	1940 (71)
110	1900 (54.5)	2190 (58)	2200 (60)	1440 (60)	1730 (66)	1740 (69)
115	1700 (52.5)	2000 (56)	2100 (58)	1240 (58.5)	1540 (64.5)	1550 (67)
120	1600 (50.5)	1800 (54)	1910 (55.5)	1140 (57)	1340 (62.5)	1450 (65)
125	1410 (48)	1700 (51.5)	1710 (53)		1240 (61)	1260 (63.5)
130	1310 (46)	1510 (49.5)	1520 (50.5)		1050 (59)	1160 (61.5)
135	1120 (43.5)	1420 (47)	1420 (48)			
140	1030 (41)	1220 (44.5)				
145		1070 (41.5)				

No load stability data

Min. boom angle at 110 ft boom length	40°	40°	47°	56°	58°	60°
Max. boom length at 0° boom angle		70 ft			40 ft	

NOTE: () Boom angles are in degrees.

A6-829-101494

*This capacity is based upon maximum boom angle.

#LMI operating code. Refer to LMI manual for instructions.

NOTES:

- All capacities above the bold line are based on structural strength of boom extension.
- 33 ft and 56 ft boom extension lengths may be used for single line lifting service.
- Radii listed are for a fully extended boom with the boom extension erected. For main boom lengths less than fully extended, the rated loads are determined by boom angle. Use only the column which corresponds to the boom extension length and offset for which the machine is configured. For boom angles not shown, use the rating of the next lower boom angle.
- WARNING:** Operation of this machine with heavier loads than the capacities listed is strictly prohibited. Machine tipping with boom extension occurs rapidly and without advance warning.
- Boom angle is the angle above or below horizontal of the longitudinal axis of the boom base section after lifting rated load.
- Capacities listed are with outriggers properly extended and vertical jacks set only.

Load handling

Weight reductions for load handling devices

11 m - 33,5 m (33 ft-56 ft) folding boom extension

*11 m (33 ft) extension (erected)	1973 kg (4350 lb)
*33,5 m (56 ft) extension (erected)	4286 kg (9450 lb)

Folding ext. with 20 ft insert

*11 m (33 ft) extension (erected)	4268 kg (9410 lb)
*33,5 m (56 ft) extension (erected)	7262 kg (16,010 lb)

Folding ext. with 40 ft insert

*11 m (33 ft) extension (erected)	7384 kg (16,280 lb)
*33,5 m (56 ft) extension (erected)	11 063 kg (24,390 lb)

*Reduction of main boom capacities
(no deduct required for stowed boom extension)

When lifting over swingaway and/or jib combinations, deduct total weight of all load handling devices reeved over main boom nose directly from swingaway or jib capacity.

Auxiliary boom nose	62 kg (137 lb)
---------------------	----------------

Hook blocks and headache balls:

53,6 t (60 Ust, 5-sheave)	510 kg + (1125 lb +)
44,6 t (50 Ust, 3-sheave)	488 kg + (1075 lb +)
35,7 t (40 Ust, 3-sheave)	356 kg + (785 lb +)
7,4 t (8.3 Ust) Headache ball (non-swivel)	159 kg + (350 lb +)
7,4 t (8.3 Ust) Headache ball (swivel)	169 kg + (370 lb +)

+ Refer to rating plate for actual weight.

NOTE: All load handling devices and boom attachments are considered part of the load and suitable allowances **MUST BE MADE** for their combined weights. Weights are for Grove furnished equipment.

Line pulls and reeving information

Hoists	Cable/Specs.	Permissible line pulls	Nominal cable length
Main	19 mm (3/4 in) 6x37 Class, EIPS, IWRC Special Flexible Min. breaking strength 26 671 kg (58,800 lb)	7620 kg (16,800 lb)	152,4 m (500 ft)
Main and Auxiliary	19 mm (.75 in) Class 35x7, Rotation Resistant (non-rotating) Min. breaking strength 38 918 kg (85,800 lb)	7620 kg (16,800 lb)	152,4 m (500 ft)

The approximate weight of 19 mm (3/4 in) wire rope is 1.5 lb /ft

Hoist performance

Wire Rope	Hoist line pulls Two speed hoist		Drum rope Capacity m (ft)	
	Low Available kg (lb) ^a	High Available kg (lb) ^a	Layer	Total
1	8225 kg (18,134 lb)	4113 kg (9067 lb)	30,8 m (101 ft)	30,8 m (101 ft)
	7560 kg (16,668 lb)	3780 kg (8334 lb)	33,5 m (110 ft)	64,3 m (211 ft)
	6994 kg (15,420 kg)	3497 kg (7710 lb)	36,6 m (120 ft)	100,9 m (331 ft)
	6508 kg (14,347 lb)	3254 kg (7174 lb)	39,3 m (129 ft)	140,2 m (460 ft)
	6084 kg (13,413 lb)	3042 kg (6707 lb)	42,4 m (139 ft)	182,6 m (599 ft)
	5713 kg (12,594 lb)	2856 kg (6297 lb)	45,4 m (149 ft)	228,0 m (758 ft)

^aMaximum lifting capacity: 6x37 or 35x7 class = 7620 kg (16,800 lb)

Working area diagram

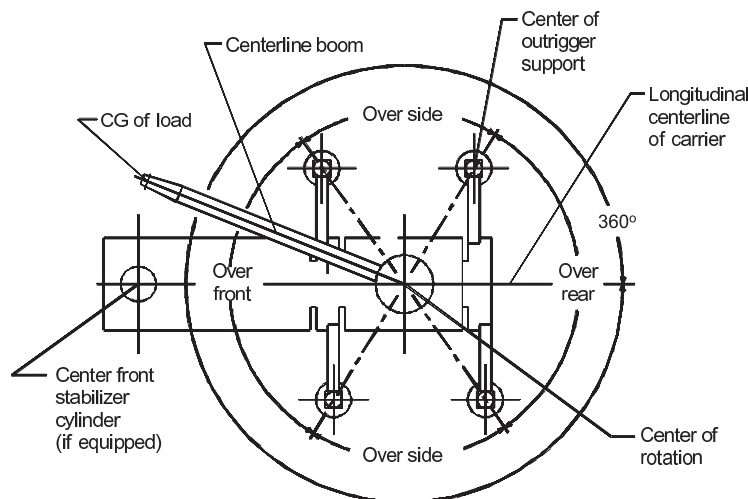

6-829-005671

Bold lines determine the limiting position of any load for operation within working areas indicated.

THIS CHART IS ONLY A GUIDE AND SHOULD NOT BE USED TO OPERATE THE CRANE.

The individual crane's load chart, operating instructions and other instructional plates must be read and understood prior to operating the crane.

Working range

Metric 85%

11 m - 33,5 m main boom and 10,1 m - 17,1 m lattice extension

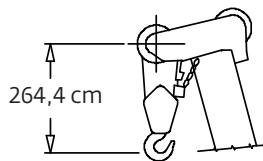
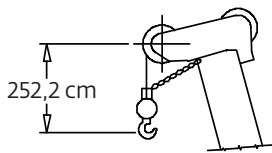
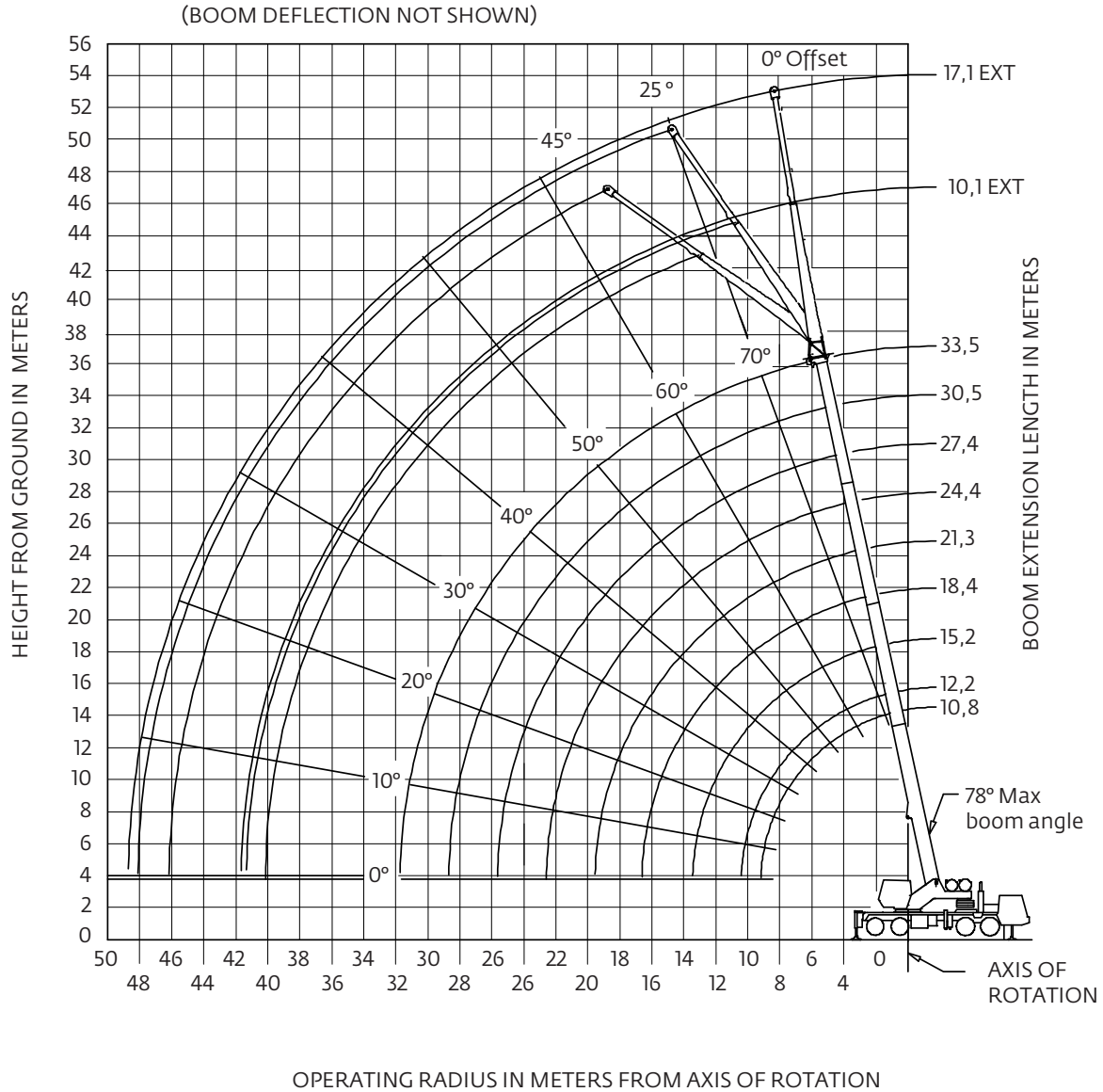

Dimensions are for largest Grove furnished hook block and headache ball, with anti-two block activated.

THIS CHART IS ONLY A GUIDE AND SHOULD NOT BE USED TO OPERATE THE CRANE.

The individual crane's load chart, operating instructions and other instructional plates must be read and understood prior to operating the crane.

Load chart

Metric 85%





11 m - 33,5 m 7485 kg 100%
6,1 m 360°

Radius in meters	#0001								
	Main boom length in meters								
	10,8	12,2	15,2	**18,4	21,3	24,4	27,4	30,5	33,5
3	55 000 (69)	38 275 (72)	36 375 (76)	*28 350 (78)					
3,5	47 400 (66,5)	38 275 (69,5)	36 375 (74)	28 350 (77,5)	*16 675 (78)				
4	43 200 (63,5)	37 975 (67)	36 375 (72)	28 075 (76)	16 675 (77,5)				
4,5	40 050 (60)	37 550 (64)	36 375 (70)	27 700 (74)	16 675 (76,5)	*16 675 (78)			
5	37 150 (57)	35 250 (61,5)	34 350 (68)	26 350 (72,5)	16 675 (75,5)	16 675 (77,5)	*14 050 (78)		
6	31 450 (50)	29 950 (55,5)	29 600 (64)	23 250 (69)	16 675 (72,5)	16 675 (75)	14 050 (77)	*13 200 (78)	
7	27 475 (42)	26 200 (49)	25 675 (59,5)	20 575 (65,5)	16 675 (69,5)	15 925 (72,5)	13 775 (75)	12 625 (77)	*10 875 (78)
8	22 050 (32)	22 725 (42)	22 175 (54,5)	18 525 (62)	16 300 (66,5)	14 850 (70)	13 075 (73)	11 925 (75)	10 650 (77)
9	13 725 (16)	18 375 (33)	18 075 (49,5)	17 375 (58,5)	15 275 (63,5)	13 350 (67,5)	11 650 (70,5)	11 075 (73)	10 050 (75)
10		13 975 (20,5)	14 950 (44)	14 525 (54,5)	13 875 (60,5)	12 075 (65)	10 675 (68,5)	10 350 (71)	9465 (73)
12			10 775 (30)	10 325 (45,5)	10 625 (53,5)	10 125 (59,5)	9275 (63,5)	8770 (67)	8475 (69,5)
14	See Note 16			7635 (35)	7965 (46)	8280 (53,5)	7910 (58,5)	7735 (62,5)	7735 (65,5)
16				5745 (19,5)	6110 (37,5)	6450 (47)	6770 (53,5)	6825 (58)	6825 (62)
18					4730 (26)	5100 (39,5)	5430 (47,5)	5625 (53,5)	5695 (57,5)
20						4045 (30,5)	4405 (41)	4575 (48)	4715 (53,5)
22						3215 (16,5)	3575 (35,5)	3750 (42,5)	3845 (48,5)
24							2905 (24)	3060 (36)	3130 (43,5)
26								2495 (28)	2605 (38)
28								2015 (16)	2140 (31)
30									1725 (22,5)
Minimum boom angle (deg.) for indicated length (no load)									0
Maximum boom length (m) at 0 degree boom angle (no load)									33,5

NOTE: () Boom angles are in degrees.
#LMI operating code. Refer to LMI manual for instructions.
*This capacity is based on maximum boom angle.

Lifting capacities at zero degree boom angle									
Boom angle	Main boom length in meters								
	10,8	12,2	15,2	**18,4	21,3	24,4	27,4	30,5	33,5
0°	13 175 (9,1)	11 075 (10,4)	7730 (13,5)	5265 (16,6)	3890 (19,6)	2995 (22,6)	2440 (25,7)	1865 (28,7)	1410 (31,8)

NOTE: () Reference radii in meters. A6-829-101600

**18,4 m boom length is with inner-mid extended and outer-mid & fly retracted.

Load chart

Metric 85%



11 m - 33,5 m



7485 kg



100%
6,1 m



Over rear

Radius in meters	#0001								
	Main boom length in meters								
	10,8	12,2	15,2	**18,4	21,3	24,4	27,4	30,5	33,5
3	55 000 (69)	38 275 (72)	36 375 (76)	**28 350 (78)					
3,5	47 400 (66,5)	38 275 (69,5)	36 375 (74)	28 350 (77,5)	*16 675 (78)				
4	43 200 (63,5)	37 975 (67)	36 375 (72)	28 075 (76)	16 675 (77,5)				
4,5	40 050 (60)	37 550 (64)	36 375 (70)	27 700 (74)	16 675 (76,5)	*16 675 (78)			
5	37 150 (57)	35 250 (61,5)	34 350 (68)	26 350 (72,5)	16 675 (75,5)	16 675 (77,5)	*14 050 (78)		
6	31 450 (50)	29 950 (55,5)	29 600 (64)	23 250 (69)	16 675 (72,5)	16 675 (75)	14 050 (77)	*13 200 (78)	
7	27 475 (42)	26 200 (49)	25 675 (59,5)	20 575 (65,5)	16 675 (69,5)	15 925 (72,5)	13 775 (75)	12 625 (77)	*10 875 (78)
8	22 050 (32)	22 925 (42)	22 175 (54,5)	18 525 (62)	16 300 (66,5)	14 850 (70)	13 075 (73)	11 925 (75)	10 650 (77)
9	13 725 (16)	20 375 (33)	18 475 (49,5)	17 375 (58,5)	15 275 (63,5)	13 350 (67,5)	11 650 (70,5)	11 075 (73)	10 050 (75)
10		13 975 (20,5)	16 125 (44)	15 125 (54,5)	13 875 (60,5)	12 075 (65)	10 675 (68,5)	10 350 (71)	9465 (73)
12			12 175 (30)	11 800 (45,5)	10 975 (53,5)	10 125 (59,5)	9275 (63,5)	8770 (67)	8475 (69,5)
14	See Note 16			8885 (35)	8690 (46)	8330 (53,5)	7910 (58,5)	7735 (62,5)	7735 (65,5)
16				6630 (19,5)	7195 (37,5)	7065 (47)	6825 (53,5)	6825 (58)	6825 (62)
18					6080 (26)	5965 (39,5)	5695 (47,5)	5695 (53,5)	5695 (57,5)
20						5115 (30,5)	4830 (41)	4715 (48)	4715 (53,5)
22						4035 (16,5)	4055 (35,5)	3845 (42,5)	3845 (48,5)
24							3370 (24)	3130 (36)	3130 (43,5)
26								2605 (28)	2605 (38)
28								2220 (16)	2170 (31)
30									1840 (22,5)
Minimum boom angle (deg.) for indicated length (no load)									0
Maximum boom length (m) at 0 degree boom angle (no load)									33,5

NOTE: () Boom angles are in degrees.

#LMI operating code. Refer to LMI manual for instructions.

*This capacity is based on maximum boom angle.

Lifting capacities at zero degree boom angle									
Boom angle	Main boom length in meters								
	10,8	12,2	15,2	**18,4	21,3	24,4	27,4	30,5	33,5
0°	13 175 (9,1)	11 075 (10,4)	7730 (13,5)	5420 (16,6)	4370 (19,6)	3540 (22,6)	2895 (25,7)	2160 (28,7)	1520 (31,8)

NOTE: () Reference radii in meters.

A6-829-101601

**18,4 m boom length is with inner-mid extended and outer-mid & fly retracted.

Load chart

Metric 85%

 11 m - 33,5 m
  10,1 m - 17 m
  7485 kg
  100%
6,1 m
  360°

Radius in meters	10,1 m LENGTH			17,1 m LENGTH		
	#0021	#0022	#0023	#0041	#0042	#0043
	0° OFFSET	25° OFFSET	45° OFFSET	0° OFFSET	25° OFFSET	45° OFFSET
9	*5850 (78)					
10	5850 (77)			*3775 (78)		
12	5850 (74,5)	*4920 (78)		3775 (77,5)		
14	5780 (71,5)	4700 (76,5)	*3360 (78)	3775 (76)		
16	5260 (69)	4355 (73,5)	3215 (76)	3760 (73,5)	*2400 (78)	
18	4665 (66)	3935 (70,5)	3100 (73)	3480 (71,5)	2345 (77)	
20	4100 (63)	3565 (67,5)	3005 (70)	3225 (69)	2310 (74,5)	*1750 (78)
22	3715 (60,5)	3250 (64,5)	2920 (67)	2990 (66,5)	2250 (72)	1690 (76,5)
24	3345 (57)	2980 (61)	2800 (63,5)	2690 (64)	2100 (69,5)	1620 (74)
26	2910 (54)	2740 (57,5)	2610 (60)	2425 (61,5)	2020 (67,5)	1560 (71)
28	2450 (50)	2540 (54)	2,435 (56)	2200 (58,5)	1920 (64,5)	1525 (68)
30	2060 (46,5)	2290 (50,5)	2280 (52)	2000 (56)	1770 (61,5)	1480 (65)
32	1720 (42,5)	1910 (46,5)	2030 (47,5)	1830 (53)	1640 (58,5)	1460 (62)
34	1425 (38,5)	1580 (42)		1635 (50)	1520 (55,5)	1425 (58,5)
36	1165 (33,5)	1285 (37)		1370 (46,5)	1410 (52)	1350 (55)
38	940 (28)	1030 (31)		1135 (43)	1315 (49)	1270 (51)
40	735 (20,5)			920 (38,5)	1130 (45)	
42				735 (34,5)	905 (40,5)	
44				560 (30)	700 (35)	
No load stability data						
Min. boom angle for indicated length	20°	25°	45°	28°	28°	45°
Max. boom length at 0° boom angle	30,5 m			27,4 m		

NOTE: () Boom angles are in degrees.

A6-829-1 01 616

*This capacity is based upon maximum boom angle.

#LMI operating code. Refer to LMI manual for instructions.

NOTES:

- All capacities above the bold line are based on structural strength of boom extension.
- 10,1 m and 17,1 m boom extension lengths may be used for single line lifting service.
- Radii listed are for a fully extended boom with the boom extension erected. For main boom lengths less than fully extended, the rated loads are determined by boom angle. Use only the column which corresponds to the boom extension length and offset for which the machine is configured. For boom angles not shown, use the rating of the next lower boom angle.
- WARNING:** Operation of this machine with heavier loads than the capacities listed is strictly prohibited. Machine tipping with boom extension occurs rapidly and without advance warning.
- Boom angle is the angle above or below horizontal of the longitudinal axis of the boom base section after lifting rated load.
- Capacities listed are with outriggers properly extended and vertical jacks set only.

Load chart

Metric 85%



11 m - 33,5 m 4990 kg

100%
6,1 m

360°

Radius in meters	#0101								
	Main boom length in meters								
	10,8	12,2	15,2	**18,4	21,3	24,4	27,4	30,5	33,5
3	55 000 (69)	38 275 (72)	36 375 (76)	*28 350 (78)					
3,5	47 400 (66,5)	38 275 (69,5)	36 375 (74)	28 350 (77,5)	*16 675 (78)				
4	43 200 (63,5)	37 975 (67)	36 375 (72)	28 075 (76)	16 675 (77,5)				
4,5	40 050 (60)	37 550 (64)	36 375 (70)	27 700 (74)	16 675 (76,5)	*16 675 (78)			
5	37 150 (57)	35 250 (61,5)	34 350 (68)	26 350 (72,5)	16 675 (75,5)	16 675 (77,5)	*14 050 (78)		
6	31 450 (50)	29 950 (55,5)	29 600 (64)	23 250 (69)	16 675 (72,5)	16 675 (75)	14 050 (77)	*13 200 (78)	
7	26 025 (42)	25 875 (49)	25 575 (59,5)	20 575 (65,5)	16 675 (69,5)	15 925 (72,5)	13 775 (75)	12 625 (77)	*10 875 (78)
8	20 050 (32)	20 000 (42)	19 650 (54,5)	18 525 (62)	16 300 (66,5)	14 850 (70)	13 075 (73)	11 925 (75)	10 650 (77)
9	13 650 (16)	16 025 (33)	15 725 (49,5)	15 325 (58,5)	15 275 (63,5)	13 350 (67,5)	11 650 (70,5)	11 075 (73)	10 050 (75)
10		13 175 (20,5)	12 925 (44)	12 525 (54,5)	12 800 (60,5)	12 075 (65)	10 675 (68,5)	10 350 (71)	9465 (73)
12			9140 (30)	8770 (45,5)	9065 (53,5)	9375 (59,5)	9275 (63,5)	8770 (67)	8475 (69,5)
14	See Note 16			6360 (35)	6690 (46)	7005 (53,5)	7320 (58,5)	7600 (62,5)	7735 (65,5)
16				4670 (19,5)	5035 (37,5)	5370 (47)	5690 (53,5)	5920 (58)	6155 (62)
18					3795 (26)	4165 (39,5)	4495 (47,5)	4690 (53,5)	4890 (57,5)
20						3220 (30,5)	3580 (41)	3750 (48)	3920 (53,5)
22						2480 (16,5)	2840 (35,5)	3010 (42,5)	3160 (48,5)
24							2240 (24)	2395 (36)	2540 (43,5)
26								1885 (28)	2025 (38)
28								1455 (16)	1580 (31)
30									1205 (22,5)
Minimum boom angle (deg.) for indicated length (no load)									0
Maximum boom length (m) at 0 degree boom angle (no load)									33,5

NOTE: () Boom angles are in degrees.

#LMI operating code. Refer to LMI manual for instructions.

*This capacity is based on maximum boom angle.

Lifting capacities at zero degree boom angle									
Boom angle	Main boom length in meters								
	10,8	12,2	15,2	**18,4	21,3	24,4	27,4	30,5	33,5
0°	13 175 (9,1)	11 075 (10,4)	7270 (13,5)	4240 (16,6)	3040 (19,6)	2285 (22,6)	1825 (25,7)	1325 (28,7)	920 (31,8)

NOTE: () Reference radii in meters.

A6-829-101602

**18,4 m boom length is with inner-mid extended and outer-mid & fly retracted.

Load chart

Metric 85%

 11 m - 33,5 m
  10,1 m - 17 m
  4990 kg
  100%
6,1 m
  360°

Radius in meters	10,1 m LENGTH			17,1 m LENGTH		
	#0121	#0122	#0123	#0141	#0142	#0143
	0° OFFSET	25° OFFSET	45° OFFSET	0° OFFSET	25° OFFSET	45° OFFSET
9	*5850 (78)					
10	5850 (77)			*3775 (78)		
12	5850 (74,5)	*4920 (78)		3775 (77,5)		
14	5780 (71,5)	4700 (76,5)	*3360 (78)	3775 (76)		
16	5260 (69)	4355 (73,5)	3215 (76)	3760 (73,5)	*2400 (78)	
18	4665 (66)	3935 (70,5)	3100 (73)	3480 (71,5)	2345 (77)	
20	4100 (63)	3565 (67,5)	3005 (70)	3225 (69)	2310 (74,5)	*1750 (78)
22	3385 (60,5)	3250 (64,5)	2920 (67)	2990 (66,5)	2250 (72)	1690 (76,5)
24	2790 (57)	2980 (61)	2800 (63,5)	2690 (64)	2100 (69,5)	1620 (74)
26	2300 (54)	2645 (57,5)	2610 (60)	2425 (61,5)	2020 (67,5)	1560 (71)
28	1890 (50)	2175 (54)	2335 (56)	2135 (58,5)	1920 (64,5)	1525 (68)
30	1540 (46,5)	1770 (50,5)	1910 (52)	1770 (56)	1770 (61,5)	1480 (65)
32	1235 (42,5)	1425 (46,5)	1545 (47,5)	1460 (53)	1640 (58,5)	1460 (62)
34	975 (38,5)	1125 (42)		1185 (50)	1520 (55,5)	1425 (58,5)
36	745 (33,5)	860 (37)		945 (46,5)	1235 (52)	1350 (55)
38	540 (28)	630 (31)		735 (43)	980 (49)	1070 (51)
40				545 (38,5)	750 (45)	
42					545 (40,5)	
No load stability data						
Min. boom angle for indicated length	25°	25°	45°	33°	36°	45°
Max. boom length at 0° boom angle	27,4 m			24,4 m		

NOTE: () Boom angles are in degrees.

A6-829-1 01 617

*This capacity is based upon maximum boom angle.





#LMI operating code. Refer to LMI manual for instructions.

NOTES:

1. All capacities above the bold line are based on structural strength of boom extension.
2. 10,1 m and 17,1 m boom extension lengths may be used for single line lifting service.
3. Radii listed are for a fully extended boom with the boom extension erected. For main boom lengths less than fully extended, the rated loads are determined by boom angle. Use only the column which corresponds to the boom extension length and offset for which the machine is configured. For boom angles not shown, use the rating of the next lower boom angle.
4. **WARNING:** Operation of this machine with heavier loads than the capacities listed is strictly prohibited. Machine tipping with boom extension occurs rapidly and without advance warning.
5. Boom angle is the angle above or below horizontal of the longitudinal axis of the boom base section after lifting rated load.
6. Capacities listed are with outriggers properly extended and vertical jacks set only.

Load chart

Metric 85%

11 m - 33,5 m 2495 kg 100%
6,1 m 360°

Radius in meters	#0201								
	Main boom length in meters								
	10,8	12,2	15,2	**18,4	21,3	24,4	27,4	30,5	33,5
3	54 500 (69)	38 275 (72)	36 375 (76)	*28 350 (78)					
3,5	47 400 (66,5)	38 275 (69,5)	36 375 (74)	28 350 (77,5)	*16 675 (78)				
4	43 200 (63,5)	37 975 (67)	36 375 (72)	28 075 (77,5)	16 675 (77,5)				
4,5	40 050 (60)	37 550 (64)	36 375 (70)	27 700 (74)	16 675 (76,5)	*16 675 (78)			
5	36 500 (57)	35 250 (61,5)	34 350 (68)	26 350 (72,5)	16 675 (75,5)	16 675 (77,5)	*14 050 (78)		
6	30 400 (50)	29 950 (55,5)	29 600 (64)	23 250 (69)	16 675 (72,5)	16 675 (75)	14 050 (77)	*13 200 (78)	
7	22 225 (42)	22 150 (49)	21 950 (59,5)	20 575 (65,5)	16 675 (69,5)	15 925 (72,5)	13 775 (75)	12 625 (77)	*10 875 (78)
8	16 875 (32)	16 875 (42)	16 675 (54,5)	16 475 (62)	16 300 (66,5)	14 850 (70)	13 075 (73)	11 925 (75)	10 650 (77)
9	13 275 (16)	13 300 (33)	13 175 (49,5)	13 000 (58,5)	13 300 (63,5)	13 350 (67,5)	11 650 (70,5)	11 075 (73)	10 050 (75)
10		10 750 (20,5)	10 700 (44)	10 500 (54,5)	10 825 (60,5)	11 150 (65)	10 675 (68,5)	10 350 (71)	9465 (73)
12	See Note 16		7335 (30)	7210 (45,5)	7525 (53,5)	7855 (59,5)	8180 (63,5)	8370 (67)	8475 (69,5)
14				5085 (35)	5425 (46)	5750 (53,5)	6075 (58,5)	6250 (62,5)	6430 (65,5)
16				3590 (19,5)	3960 (37,5)	4295 (47)	4620 (53,5)	4790 (58)	4955 (62)
18					2860 (26)	3225 (39,5)	3555 (47,5)	3715 (53,5)	3875 (57,5)
20						2385 (30,5)	2740 (41)	2895 (48)	3055 (53,5)
22						1725 (16,5)	2075 (35,5)	2250 (42,5)	2405 (48,5)
24							1535 (24)	1710 (36)	1875 (43,5)
26								1265 (28)	1435 (38)
28								890 (16)	1055 (31)
30									735 (22,5)
Minimum boom angle (deg.) for indicated length (no load)									0
Maximum boom length (m) at 0 degree boom angle (no load)									33,5

NOTE: () Boom angles are in degrees.
#LMI operating code. Refer to LMI manual for instructions.
*This capacity is based on maximum boom angle.

Lifting capacities at zero degree boom angle										
Boom angle	Main boom length in meters									
	10,8	12,2	15,2	**18,4	21,3	24,4	27,4	30,5		
0°	13 075 (9,1)	9905 (10,4)	5675 (13,5)	3210 (16,6)	2190 (19,6)	1550 (22,6)	1165 (25,7)	775 (28,7)		

NOTE: () Reference radii in meters.

A6-829-101604

**18,4 m boom length is with inner-mid extended and outer-mid & fly retracted.

Load chart

Metric 85%



11 m - 33,5 m



2495 kg



100%
6,1 m



Over rear

Radius in meters	#0201								
	Main boom length in meters								
	10,8	12,2	15,2	**18,4	21,3	24,4	27,4	30,5	33,5
3	55 000 (69)	38 275 (72)	36 375 (76)	*28 350 (78)					
3,5	47 400 (66,5)	38 275 (69,5)	36 375 (74)	28 350 (77,5)	*16 675 (78)				
4	43 200 (63,5)	37 975 (67)	36 375 (72)	28 075 (76)	16 675 (77,5)				
4,5	40 050 (60)	37 550 (64)	36 375 (70)	27 700 (74)	16 675 (76,5)	*16 675 (78)			
5	36 500 (57)	35 250 (61,5)	34 350 (68)	26 350 (72,5)	16 675 (75,5)	16 675 (77,5)	*14 050 (78)		
6	30 400 (50)	29 950 (55,5)	29 600 (64)	23 250 (69)	16 675 (72,5)	16 675 (75)	14 050 (77)	*13 200 (78)	
7	25 650 (42)	25 400 (49)	25 175 (59,5)	20 575 (65,5)	16 675 (69,5)	15 925 (72,5)	13 775 (75)	12 625 (77)	*10 875 (78)
8	20 200 (32)	21 425 (42)	21 275 (54,5)	18 525 (62)	16 300 (66,5)	14 850 (70)	13 075 (73)	11 925 (75)	10 650 (77)
9	13 600 (16)	17 800 (33)	17 850 (49,5)	17 375 (58,5)	15 275 (63,5)	13 350 (67,5)	11 650 (70,5)	11 075 (73)	10 050 (75)
10		13 300 (20,5)	14 675 (44)	14 650 (54,5)	13 875 (60,5)	12 075 (65)	10 675 (68,5)	10 350 (71)	9465 (73)
12			10 375 (30)	10 375 (45,5)	10 750 (53,5)	10 125 (59,5)	9275 (63,5)	8770 (67)	8475 (69,5)
14	See Note 16			7660 (35)	8035 (46)	8330 (53,5)	7910 (58,5)	7735 (62,5)	7735 (65,5)
16				5750 (19,5)	6145 (37,5)	6510 (47)	6825 (53,5)	6825 (58)	6825 (62)
18					4740 (26)	5120 (39,5)	5460 (47,5)	5625 (53,5)	5695 (57,5)
20						4035 (30,5)	4395 (41)	4550 (48)	4705 (53,5)
22						3180 (16,5)	3535 (35,5)	3705 (42,5)	3845 (48,5)
24							2840 (24)	3010 (36)	3130 (43,5)
26								2430 (28)	2590 (38)
28								1945 (16)	2105 (31)
30									1685 (22,5)
Minimum boom angle (deg.) for indicated length (no load)									
Maximum boom length (m) at 0 degree boom angle (no load)									
									33,5

NOTE: () Boom angles are in degrees.

#LMI operating code. Refer to LMI manual for instructions.

*This capacity is based on maximum boom angle.

Boom angle	Lifting capacities at zero degree boom angle								
	Main boom length in meters								
	10,8	12,2	15,2	**18,4	21,3	24,4	27,4	30,5	33,5
0°	13 175 (9,1)	11 075 (10,4)	7730 (13,5)	5270 (16,6)	3880 (19,6)	2955 (22,6)	2355 (25,7)	1790 (28,7)	1370 (31,8)

NOTE: () Reference radii in meters.

A6-829-101605

**18,4 m boom length is with inner-mid extended and outer-mid & fly retracted.

THIS CHART IS ONLY A GUIDE AND SHOULD NOT BE USED TO OPERATE THE CRANE.

The individual crane's load chart, operating instructions and other instructional plates must be read and understood prior to operating the crane.

Load chart

Metric 85%

 11 m - 33,5 m
  10,1 m - 17 m
  2495 kg
  100%
6,1 m
  360°

Radius in meters	10,1 m LENGTH			17,1 m LENGTH		
	#0221	#0222	#0223	#0241	#0242	#0243
	0° OFFSET	25° OFFSET	45° OFFSET	0° OFFSET	25° OFFSET	45° OFFSET
9	*5850 (78)					
10	5850 (77)			*3775 (78)		
12	5850 (74,5)	*4920 (78)		3775 (77,5)		
14	5780 (71,5)	4700 (76,5)	*3360 (78)	3775 (76)		
16	5190 (69)	4355 (73,5)	3215 (76)	3760 (73,5)	*2400 (78)	
18	4115 (66)	3935 (70,5)	3100 (73)	3480 (71,5)	2345 (77)	
20	3295 (63)	3565 (67,5)	3005 (70)	3225 (69)	2310 (74,5)	*1750 (78)
22	2650 (60,5)	3070 (64,5)	2920 (67)	2990 (66,5)	2250 (72)	1690 (76,5)
24	2125 (57)	2480 (61)	2760 (63,5)	2435 (64)	2100 (69,5)	1620 (74)
26	1695 (54)	2000 (57,5)	2225 (60)	1975 (61,5)	2020 (67,5)	1560 (71)
28	1330 (50)	1590 (54)	1775 (56)	1590 (58,5)	1920 (64,5)	1525 (68)
30	1020 (46,5)	1245 (50,5)	1395 (52)	1260 (56)	1715 (61,5)	1480 (65)
32	755 (42,5)	945 (46,5)	1065 (47,5)	980 (53)	1375 (58,5)	1460 (62)
34	525 (38,5)	685 (42)		735 (50)	1075 (55,5)	1230 (58,5)
36				515 (46,5)	810 (52)	935 (55)
38					580 (49)	670 (51)
No load stability data						
Min. boom angle for indicated length	37°	37°	45°	45°	46°	48°
Max. boom length at 0° boom angle	24,4 m			18,4 m		

NOTE: () Boom angles are in degrees.

A6-829-1 01 618

*This capacity is based upon maximum boom angle.

#LMI operating code. Refer to LMI manual for instructions.

NOTES:

1. All capacities above the bold line are based on structural strength of boom extension.
2. 10,1 m and 17,1 m boom extension lengths may be used for single line lifting service.
3. Radii listed are for a fully extended boom with the boom extension erected. For main boom lengths less than fully extended, the rated loads are determined by boom angle. Use only the column which corresponds to the boom extension length and offset for which the machine is configured. For boom angles not shown, use the rating of the next lower boom angle.
4. **WARNING:** Operation of this machine with heavier loads than the capacities listed is strictly prohibited. Machine tipping with boom extension occurs rapidly and without advance warning.
5. Boom angle is the angle above or below horizontal of the longitudinal axis of the boom base section after lifting rated load.
6. Capacities listed are with outriggers properly extended and vertical jacks set only.

Load chart

Metric 85%





11 m - 33,5 m 0 kg 100%
6,1 m Over rear

Radius in meters	#0801								
	Main boom length in meters								
	10,8	12,2	15,2	**18,4	21,3	24,4	27,4	30,5	33,5
3	55 000 (69)	38 275 (72)	36 375 (76)	**28 350 (78)					
3,5	47 400 (66,5)	38 275 (69,5)	36 375 (74)	28 350 (77,5)	*16 675 (78)				
4	43 200 (63,5)	37 975 (67)	36 375 (72)	28 075 (76)	16 675 (77,5)				
4,5	40 050 (60)	37 550 (64)	36 375 (70)	27 700 (74)	16 675 (76,5)	*16 675 (78)			
5	36 200 (57)	34 400 (61,5)	34 025 (68)	26 350 (72,5)	16 675 (75,5)	16 675 (77,5)	*14 050 (78)		
6	29 025 (50)	28 650 (55,5)	28 475 (64)	23 250 (69)	16 675 (72,5)	16 675 (75)	14 050 (77)	*13 200 (78)	
7	24 225 (42)	24 125 (49)	23 950 (59,5)	20 575 (65,5)	16 675 (69,5)	15 925 (72,5)	13 775 (75)	12 625 (77)	*10 875 (78)
8	19 250 (32)	19 450 (42)	19 475 (54,5)	18 350 (62)	16 300 (66,5)	14 850 (70)	13 075 (73)	11 925 (75)	10 650 (77)
9	13 550 (16)	15 425 (33)	15 475 (49,5)	15 475 (58,5)	15 275 (63,5)	13 350 (67,5)	11 650 (70,5)	11 075 (73)	10 050 (75)
10		12 550 (20,5)	12 625 (44)	12 600 (54,5)	13 000 (60,5)	12 075 (65)	10 675 (68,5)	10 350 (71)	9465 (73)
12			8815 (30)	8800 (45,5)	9175 (53,5)	9565 (59,5)	9275 (63,5)	8770 (67)	8475 (69,5)
14	See Note 16			6370 (35)	6745 (46)	7110 (53,5)	7475 (58,5)	7660 (62,5)	7735 (65,5)
16				4660 (19,5)	5055 (37,5)	5415 (47)	5765 (53,5)	5935 (58)	6110 (62)
18					3795 (26)	4175 (39,5)	4515 (47,5)	4680 (53,5)	4840 (57,5)
20						3205 (30,5)	3565 (41)	3720 (48)	3875 (53,5)
22						2435 (16,5)	2790 (35,5)	2960 (42,5)	3110 (48,5)
24							2165 (24)	2335 (36)	2495 (43,5)
26								1815 (28)	1980 (38)
28								1380 (16)	1540 (31)
30									1165 (22,5)
Minimum boom angle (deg.) for indicated length (no load)									0
Maximum boom length (m) at 0 degree boom angle (no load)									33.5

NOTE: () Boom angles are in degrees.
#LMI operating code. Refer to LMI manual for instructions.
*This capacity is based on maximum boom angle.

Boom angle	Lifting capacities at zero degree boom angle								
	Main boom length in meters								
	10,8	12,2	15,2	**18,4	21,3	24,4	27,4	30,5	33,5
0°	13 175 (9,1)	11 075 (10,4)	6930 (13,5)	4225 (16,6)	3025 (19,6)	2235 (22,6)	1730 (25,7)	1240 (28,7)	880 (31,8)

NOTE: () Reference radii in meters. A6-829-101607
**18,4 m boom length is with inner-mid extended and outer-mid & fly retracted.

Load chart

Metric 85%



11 m - 33,5 m



10,1 m - 17 m



0 kg



100%
6,1 m



360°

Radius in meters	10,1 m LENGTH			17,1 m LENGTH		
	#0821	#0822	#0823	#0841	#0842	#0843
	0° OFFSET	25° OFFSET	45° OFFSET	0° OFFSET	25° OFFSET	45° OFFSET
9	*5850 (78)					
10	5850 (77)			*3775 (78)		
12	5850 (74,5)	*4920 (78)		3775 (77,5)		
14	5585 (71,5)	4700 (76,5)	*3360 (78)	3775 (76)		
16	4265 (69)	4355 (73,5)	3215 (76)	3760 (73,5)	*2400 (78)	
18	3295 (66)	3915 (70,5)	3100 (73)	3480 (71,5)	2345 (77)	
20	2555 (63)	3070 (67,5)	3005 (70)	2850 (69)	2310 (74,5)	*1750 (78)
22	1970 (60,5)	2405 (64,5)	2670 (67)	2250 (66,5)	2250 (72)	1690 (76,5)
24	1500 (57)	1870 (61)	2090 (63,5)	1765 (64)	2100 (69,5)	1620 (74)
26	110 (54)	1425 (57,5)	1615 (60)	1365 (61,5)	1845 (67,5)	1560 (71)
28	780 (50)	1055 (54)	1215 (56)	1030 (58,5)	1460 (64,5)	1525 (68)
30	505 (46,5)	735 (50,5)	875 (52)	745 (56)	1130 (61,5)	1440 (65)
32			580 (47,5)		845 (58,5)	1085 (62)
34					600 (55,5)	780 (58,5)
36						510 (55)
No load stability data						
Min. boom angle for indicated length	46°	45°	45°	48°	51°	51°
Max. boom length at 0° boom angle	18,4 m			15,2 m		

NOTE: () Boom angles are in degrees.

*This capacity is based upon maximum boom angle.

#LMI operating code. Refer to LMI manual for instructions.

A6-829-1 01 619

NOTES:

1. All capacities above the bold line are based on structural strength of boom extension.
2. 10,1 m and 17,1 m boom extension lengths may be used for single line lifting service.
3. Radii listed are for a fully extended boom with the boom extension erected. For main boom lengths less than fully extended, the rated loads are determined by boom angle. Use only the column which corresponds to the boom extension length and offset for which the machine is configured. For boom angles not shown, use the rating of the next lower boom angle.
4. **WARNING:** Operation of this machine with heavier loads than the capacities listed is strictly prohibited. Machine tipping with boom extension occurs rapidly and without advance warning.
5. Boom angle is the angle above or below horizontal of the longitudinal axis of the boom base section after lifting rated load.
6. Capacities listed are with outriggers properly extended and vertical jacks set only.

Working range

Metric 85%

11 m - 33,5 m main boom and 10,1 m - 17,1 m lattice extension with 12,2 m insert

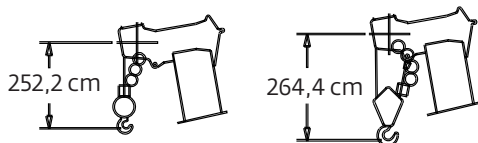
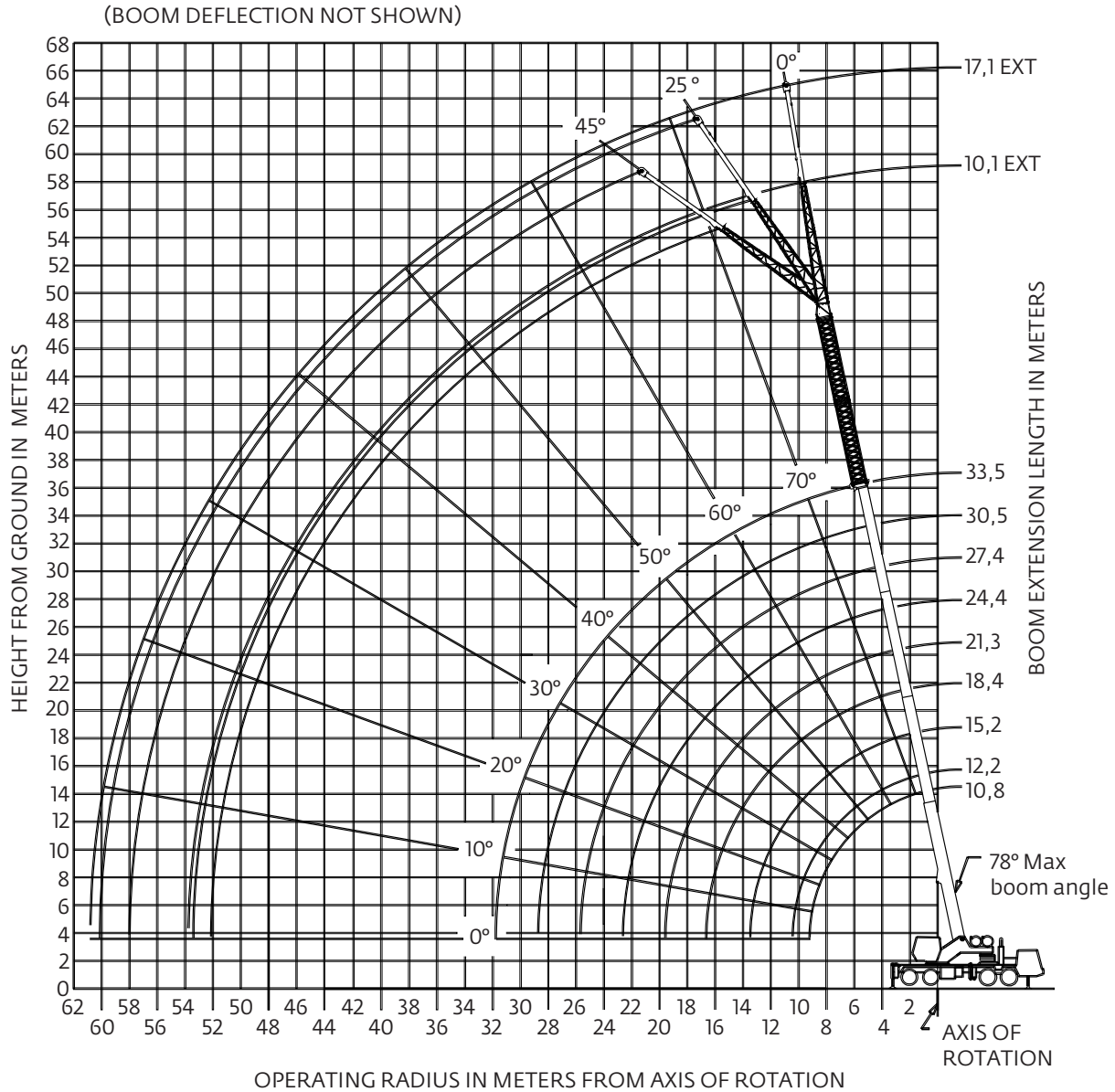

Dimensions are for largest Grove furnished hook block and headache ball, with anti-two block activated.

Load chart

Metric 85%

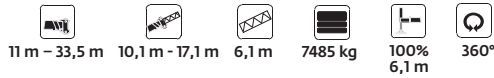

Radius in meters	10,1 m LENGTH			17,1 m LENGTH		
	#0064	#0065	#0066	#0084	#0085	#0086
	0° OFFSET	25° OFFSET	45° OFFSET	0° OFFSET	25° OFFSET	45° OFFSET
12	4245 (78)					
14	3775 (75,5)	*3390 (78)		2830 (78)		
16	3320 (73)	3070 (77)	*2665 (78)	2715 (76)		
18	2950 (70,5)	2750 (74,5)	2520 (77)	2710 (74)		
20	2640 (68)	2495 (72)	2285 (74,5)	2470 (72)	2170 (78)	
22	2365 (65,5)	2240 (69,5)	2105 (71,5)	2180 (69,5)	1935 (76)	*1705 (78)
24	2145 (63)	2035 (66,5)	1930 (69)	1935 (67,5)	1775 (73,5)	1600 (77,5)
26	1940 (60)	1870 (64)	1755 (66)	1725 (65)	1610 (71,5)	1470 (75)
28	1770 (57)	1710 (61)	1640 (63)	1545 (62,5)	1460 (69)	1310 (72,5)
30	1625 (54,5)	1580 (58)	1525 (60)	1385 (60,5)	1330 (66,5)	1190 (70)
32	1475 (51)	1455 (55)	1405 (56,5)	1260 (58)	1215 (64)	1115 (67)
34	1360 (48)	1345 (51,5)	1305 (53)	1120 (55)	1095 (61,5)	1040 (64,5)
36	1225 (44,5)	1260 (48)	1180 (49)	1015 (52,5)	995 (58,5)	955 (61,5)
38	995 (41)	1145 (44,5)		910 (50)	905 (55,5)	870 (58,5)
40	790 (37)	910 (40)		825 (47)	825 (52,5)	805 (55)
42	605 (32)	695 (35,5)		735 (44)	755 (49,5)	705 (51,5)
44		505 (30)			695 (46)	
46					545 (42,5)	
No load stability data						
Min. boom angle at 33,5 m boom length	22°	29°	45°	38°	40°	45°
Max. boom length at 0° boom angle	30,5 m			24,4 m		

NOTE: () Boom angles are in degrees.

A6-829-1 01 624

*This capacity is based upon maximum boom angle.







#LMI operating code. Refer to LMI manual for instructions.

NOTES:

1. All capacities above the bold line are based on structural strength of boom extension.
2. 10,1 m and 17,1 m boom extension lengths may be used for single line lifting service.
3. Radii listed are for a fully extended boom with the boom extension erected. For main boom lengths less than fully extended, the rated loads are determined by boom angle. Use only the column which corresponds to the boom extension length and offset for which the machine is configured. For boom angles not shown, use the rating of the next lower boom angle.
4. **WARNING:** Operation of this machine with heavier loads than the capacities listed is strictly prohibited. Machine tipping with boom extension occurs rapidly and without advance warning.
5. Boom angle is the angle above or below horizontal of the longitudinal axis of the boom base section after lifting rated load.
6. Capacities listed are with outriggers properly extended and vertical jacks set only.

Load chart

Metric 85%

 11 m - 33,5 m
  10,1 m - 17,1 m
  12,2 m
  7485 kg
  100% 6,1 m
  360°

Radius in meters	10,1 m LENGTH			17,1 m LENGTH		
	#0064	#0065	#0066	#0084	#0085	#0086
	0° OFFSET	25° OFFSET	45° OFFSET	0° OFFSET	25° OFFSET	45° OFFSET
14	2925 (77,5)					
16	2565 (75,5)	*2655 (78)		1975 (78)		
18	2245 (73)	2435 (77)	*2345 (78)	1795 (76)		
20	1960 (71)	2180 (74,5)	2095 (77)	1665 (74)		
22	1740 (68,5)	1920 (72,5)	1875 (74,5)	1505 (72)	1625 (78)	
24	1525 (66,5)	1710 (70)	1700 (72,5)	1325 (70)	1445 (76,5)	
26	1345 (64)	1520 (67,5)	1525 (70)	1135 (68)	1270 (74)	1230 (77,5)
28	1210 (61,5)	1360 (65,5)	1365 (67,5)	1000 (66)	1135 (72)	1115 (75,5)
30	1065 (59)	1210 (63)	1245 (64,5)	855 (64)	995 (70)	995 (73)
32	945 (56,5)	1080 (60)	1080 (62)	740 (62)	875 (68)	880 (71)
34	830 (54)	965 (57,5)	980 (59,5)	625 (59,5)	755 (65,5)	760 (68,5)
36	740 (51,5)	850 (55)	895 (56,5)	530 (57,5)	640 (63,5)	675 (66)
38	645 (48,5)	770 (52)	780 (53,5)		565 (61)	575 (63,5)
40	570 (45,5)	675 (49)	675 (50)			505 (61)
42		590 (45,5)	615 (46,5)			
44		505 (42)				
No load stability data						
Min. boom angle at 33,5 m boom length	40°	40°	46°	56°	58°	60°
Max. boom length at 0° boom angle	21,3 m			12,2 m		

NOTE: () Boom angles are in degrees.

A6-829-1 01 628A

*This capacity is based upon maximum boom angle.

#LMI operating code. Refer to LMI manual for instructions.

NOTES:

- All capacities above the bold line are based on structural strength of boom extension.
- 10,1 m and 17,1 m boom extension lengths may be used for single line lifting service.
- Radii listed are for a fully extended boom with the boom extension erected. For main boom lengths less than fully extended, the rated loads are determined by boom angle. Use only the column which corresponds to the boom extension length and offset for which the machine is configured. For boom angles not shown, use the rating of the next lower boom angle.
- WARNING:** Operation of this machine with heavier loads than the capacities listed is strictly prohibited. Machine tipping with boom extension occurs rapidly and without advance warning.
- Boom angle is the angle above or below horizontal of the longitudinal axis of the boom base section after lifting rated load.
- Capacities listed are with outriggers properly extended and vertical jacks set only.

Symbols glossary



Axles



Counterweight



Grade



Outriggers



Boom



Drive



Heavy duty jib



Radius



Boom elevation



Electrical system



Hoist



Rotation



Boom extension



Engine



Hookblock



Speed



Boom length



Extension



Hydraulic system



Steering



Boom nose



Frame



Lights



Suspension



Brakes



Fuel tank capacity



Oil



Swing



Cab



Gear



Outrigger controls



Tires



Transmission

Manitowoc Cranes

Regional headquarters

Americas

Manitowoc, Wisconsin, USA

Tel: +1 920 684 6621

Fax: +1 920 683 6277

Shady Grove, Pennsylvania, USA

Tel: +1 717 597 8121

Fax: +1 717 597 4062

Europe, Middle East, Africa

Dardilly, France

Tel: +33 (0)4 72 18 20 20

Fax: +33 (0)4 72 18 20 00

China

Shanghai, China

Tel: +86 21 6457 0066

Fax: +86 21 6457 4955

Greater Asia-Pacific

Singapore

Tel: +65 6264 1188

Fax: +65 6862 4040

Regional offices

Americas

Brazil

Alphaville

Mexico

Monterrey

Chile

Santiago

Europe, Middle East, Africa

France

Baudemont

Cergy

Decines

Germany

Langenfeld

Italy

Lainate

Netherlands

Breda

Poland

Warsaw

Portugal

Baltar

Russia

Moscow

South Africa

Johannesburg

U.A.E.

Dubai

U.K.

Buckingham

China

Beijing

Chengdu

Guangzhou

Xian

Greater Asia-Pacific

Australia

Brisbane

Melbourne

Sydney

India

Chennai

Delhi

Hyderabad

Pune

Korea

Seoul

Philippines

Makati City

Singapore

Factories

Brazil

Passo Fundo

China

TaiAn

Zhangjiagang

France

Charlieu

Moulins

Germany

Wilhelmshaven

India

Pune

Italy

Niella Tanaro

Portugal

Baltar

Fânzeres

Slovakia

Saris

USA

Manitowoc

Port Washington

Shady Grove

This document is non-contractual. Constant improvement and engineering progress make it necessary that we reserve the right to make specification, equipment, and price changes without notice. Illustrations shown may include optional equipment and accessories and may not include all standard equipment.